

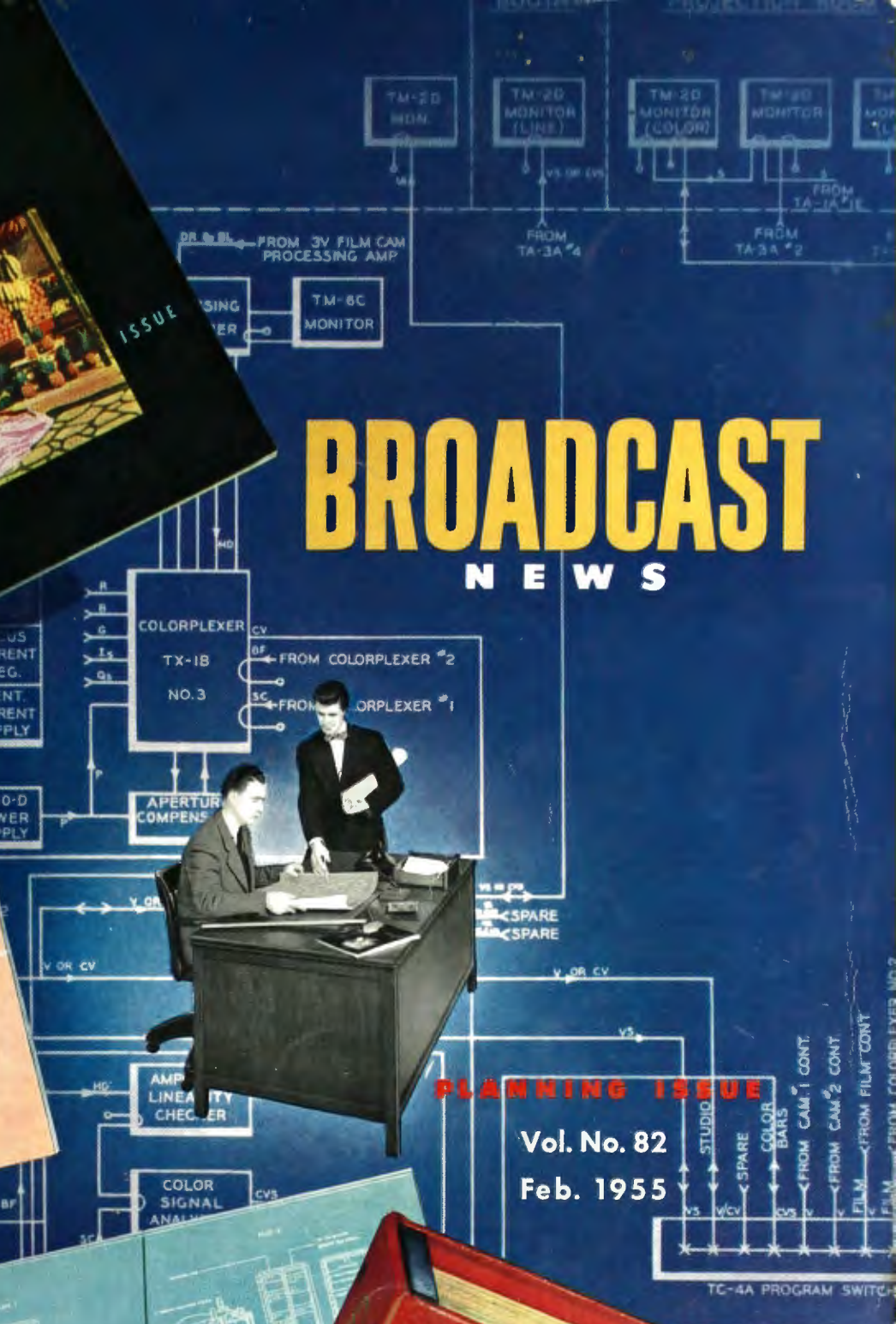

BROADCAST NEWS



PLANNING ISSUE

Vol. No. 82
Feb. 1955



BROADCAST NEWS



Extra Program Versatility from **NEW RCA TS-11A Switcher**

The TS-11A is a "nine-input" switcher designed to handle composite or non-composite video switching for color or monochrome. Two rows of push buttons feed a manual fader assembly; a third row feeds a preview channel. A program transfer switch is provided to interchange the preview and fader busses with the output busses so that the fader section can be used for previewing fades, lap dissolves and superimpositions. This makes it possible to use the fader channels for rehearsals while the preview channel handles the "on-air" signal. The fader assembly feeds a mixing circuit and three output amplifiers which are a part of the TS-11A, eliminating the need for installing elaborate distribution amplifier systems external to the switcher. The new switcher is free of microphonics and low frequency tilt and bounce, so that a stabilizing amplifier need not be added as part of the switching system.

For further information about this exclusive RCA development get in touch with your RCA Broadcast Sales Representative. In Canada, write RCA Victor Ltd., Montreal.



The TS-11A Switcher is supplied with an RCA console housing (MI-26266-B), a TM-6B master monitor and power supplies to form a complete versatile system.



RCA PIONEERED AND DEVELOPED COMPATIBLE COLOR TELEVISION

RADIO CORPORATION of AMERICA

ENGINEERING PRODUCTS DIVISION CAMDEN, N. J.

BROADCAST NEWS

published by

RADIO CORPORATION OF AMERICA
ENGINEERING PRODUCTS DIVISION CAMDEN, NEW JERSEY

PRICE *In continental U.S.A. --- \$4.00 for 12 issues*
In other countries ----- \$5.00 for 12 issues

C O N T E N T S

ONE MILLION WATTS "ON-AIR" AT WBRE-TV 6

PATTERN MEASUREMENTS OF RCA
UHF TV ANTENNAS . . . by *E. H. Shively and L. D. Wetzel* 14

WIND VELOCITY AND ITS EFFECT ON
TRANSMITTING ANTENNAS AND TOWERS *by D. W. Balmer* 22

COLOR EQUIPMENT PLANNING *by L. E. Anderson* 28

TS-11A SWITCHER OFFERS NEW "PREVIEW"
AND "REHEARSAL" FEATURES *by C. R. Monro* 57

REDUCTION OF SPURIOUS SIGNALS
IN IMAGE ORTHICON CAMERAS *by V. I. Rotow* 60

"RCA PIONEERED AND DEVELOPED COMPATIBLE COLOR TELEVISION"



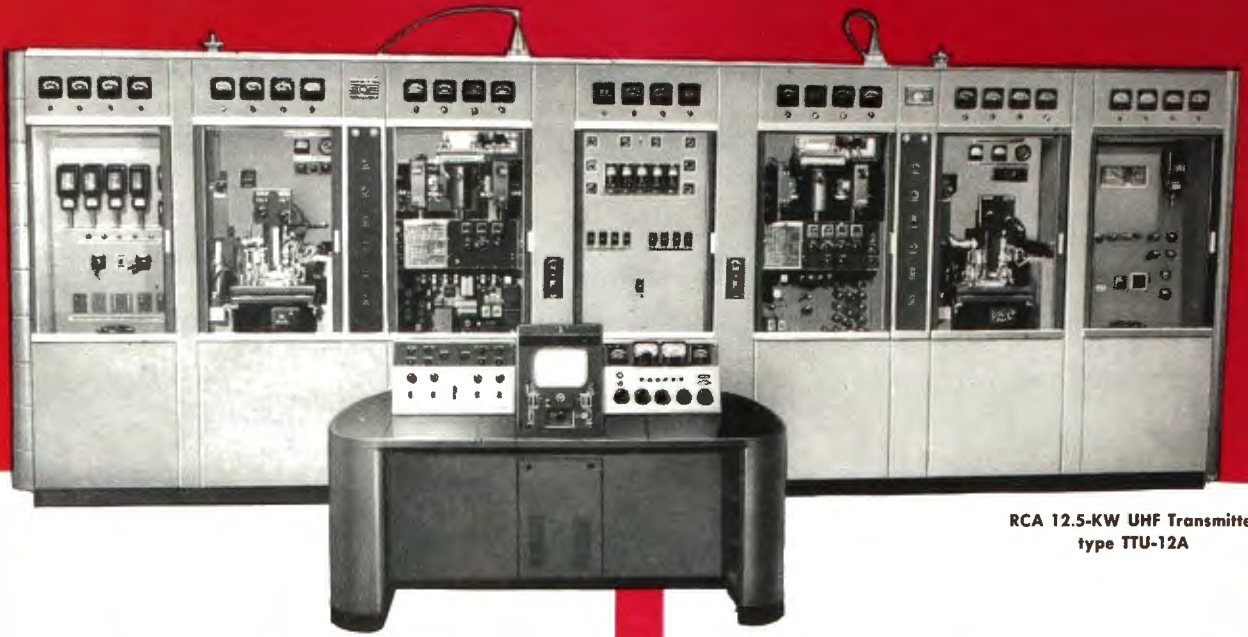

RCA 12.5-KW UHF Transmitter
type TTU-12A

① 12.5-KW UHF Power Available

With RCA's new transmitter, you get full 12½-kilowatt output (at the low end of the band). Moreover, you get this with all adjustments made for optimum color transmission—and with an extra-large allowance (10%) for losses in the Filterplexer. In most cases, loss is actually much less, so that output on some channels is nearly 14 KW.

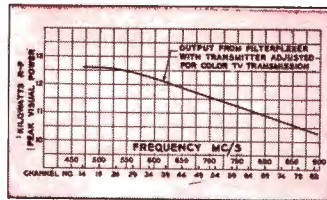

② Up To 750 KW ERP

Operated in combination with an RCA high-gain UHF Pylon Antenna, Types TFU-46AL/52AM/60AH, this 12.5-KW transmitter is capable of providing an ERP up to 750 KW.

③ Designed for Color

Performance requirements for color are much more stringent than for monochrome. The TTU-12A was designed to meet color requirements. Over-all linearity is virtually a straight line—from white level to sync signal peaks. Wide band width provides excellent response out to 4.2 MC. And the very important phase vs. amplitude response is constant over the whole operating range.

Curve illustrating the linearity characteristic of the RCA TTU-12A transmitter. This overall performance curve was obtained by feeding the transmitter input through an RCA TA-7A Color Stabilizing Amplifier.

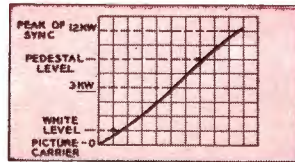

A linearity trace (taken directly from an oscilloscope) of the TTU-12A transmitter at 12 KW "peak-of-sync."

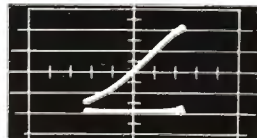

Another linearity trace (taken directly from an oscilloscope) of the TTU-12A when driving the TA-7A to 12 KW "peak-of-sync." "P.A." output.



④ Unsurpassed Monochrome Quality

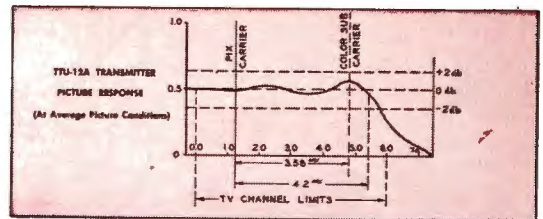

Equally important—you get SUPER MONOCHROME QUALITY with this RCA UHF transmitter. It exceeds FCC requirements for satisfactory monochrome operation by a wide margin! Since the RCA transmitter is adjusted for the more stringent color requirements, it is particularly good for monochrome.

⑤ Conventional Tubes Throughout



The latest circuit principles and techniques are employed in the TTU-12A—but they are easily understood by all station operators. That's because *only conventional type tubes are used*. For example, the RCA-developed high-power retrodde (RCA-6448) is used in both aural and visual "P.A.'s".

This tube is small and easy to handle—fits into a unique "glide-in" cavity assembly that can be interchanged quickly and easily. The result is a high-power UHF transmitter that is as simple, reliable, and convenient to operate as standard broadcast transmitters.

⑥ Economical To Operate

Average power consumption of the TTU-12A is less than other UHF transmitters of equivalent power. Tubes are designed for long operating life. At conservative estimates, these provide total savings up to \$34,000—based on a 10-year operation. See the typical readings and performance characteristics in Table I.

TABLE I

(Typical Transmitter Specifications and Meter Readings)

Transmitter Power Consumption (approx.):		
Average Picture	.85 KW	
Power Factor	.0.9	
Transmitter Output Meter Readings:		
Peak of Sync	14.0 KW	8.4 KW
Power Output (transmitter)	12.6 KW	7.6 KW
Power Output (Filterplexer)	47.6%	33.3%
Plate Efficiency		
Transmitter Overall Dimensions:		
Width (front line cabinets)	.235"	
Height	.84"	
Depth	.32-9/16"	
Weight	.6000 lbs. (approx.)	

Why RCA's 12.5-KW IS PREFERRED BY UHF STATIONS

7 RCA 1-KW Driver—Plenty of Reserve

The RCA 12.5-KW UHF transmitter uses the famous RCA TTU-1B 1-KW UHF transmitter as the driver. This transmitter, now used by nearly a hundred UHF stations, has established an outstanding record for performance and reliability. If you want to begin UHF operations with one kilowatt now, you can do so with an RCA TTU-1B 1-KW transmitter. Then add an RCA 12.5-KW UHF power amplifier later.

8 Space-Saving Mechanical Features

Horizontally sliding doors, front and back, save on workable floor space—give the operators more elbow room. Small cubicles (27" wide, 32" deep, 84" high) enable you to move them through standard doorways and in and out of standard elevators. Pre-formed inter-cabinet connecting cables reduce installation costs.

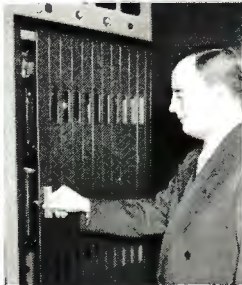

9 10 Micro-Second, Fault-Protection

Unique electronic overload protection completely safeguards power tubes and circuitry against momentary or sustained overload. (For example, the protection circuit will remove power so fast it will prevent damage to a wire as fine as 0.005-inch diameter shorted across the 7000-volt power supply!)

10 Hi-Lo Cutback Reduces "Off-Air" Time

With the TTU-12A transmitter you can cut back to a generous 1-KW power level—and stay "on-air" while making emergency repairs to the 12½-KW amplifier. Moreover, small size tube cavities in the power amplifiers may be interchanged in less than 5 minutes—enabling you to return to full power promptly.

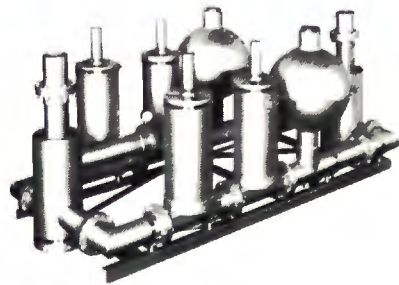

RCA TTU-12A Filterplexer

11 You Pay Nothing for "Extras"

The price of the RCA 12.5-KW UHF includes the complete transmitter package. No "extra" charge for UHF Filterplexer (combination sideband filter and diplexer). No "extra" charge for one complete set of tubes. No "extra" charge for two sets of crystals, two P.A. "glide-in" cavity dollies, one spare cavity, two water pumps, and pyranol-filled plate transformer.

Specify a Completely Matched UHF System

RCA can supply a completely matched system to meet any station requirement. This includes the antenna and tower, transmitter, console, monitoring equipment, transmission line or waveguide, and the many other accessories needed to put a UHF station on the air. Everything is matched for peak performance and you get everything from one reliable source—RCA!



RCA UHF Waveguide Section

For complete information on the RCA 12.5-KW UHF transmitter—and RCA UHF accessories—call your RCA Broadcast Sales Representative.

New brochure on the RCA 12.5-KW UHF transmitter. Includes technical specifications, floor plans. Free from your RCA Broadcast Sales Representative.

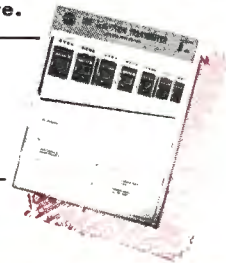

RCA PIONEERED AND DEVELOPED COMPATIBLE COLOR TELEVISION



RADIO CORPORATION of AMERICA
ENGINEERING PRODUCTS DIVISION

CAMDEN, N.J.

1,000,000 WATTS

RCA IS FIRST WITH SUPER



This 25-KW Amplifier +

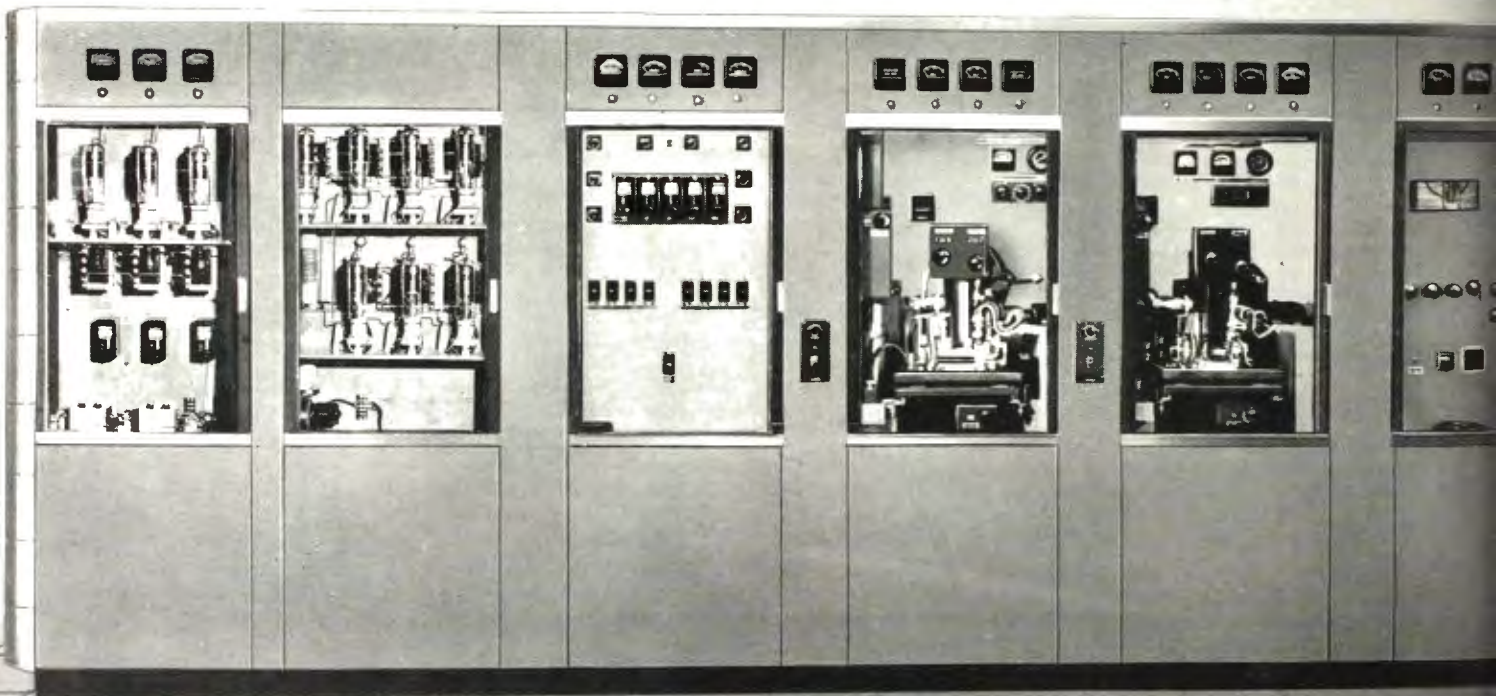

'ON-AIR" AT WBRE-TV

OWER UHF

This announcement marks another achievement in RCA high-power equipment leadership. For the first time, a commercial UHF television station is operating with an effective radiated power of one million watts! For the first time, a UHF station is getting coverage close-in AND far out! And best of all, super television power has proved just as easy to handle as lower powers.

How do you get started with RCA super power? You begin with your own RCA 1-KW transmitter. You add the new RCA 25-KW amplifier. You install the new RCA Super Power UHF Pylon (gain, 46)—and you're set to go with 1 million watts ERP. Power tubes in both RCA high-power amplifiers are conventional and interchangeable (no klystrons used). Amplifier plate voltages are low (6000 volts, max.). Operating economy is remarkable (RCA's new super power, high-gain antenna eliminates need for high power input. Power tubes have already set a record for "proved-in" life).

this Antenna = One million Watts

New RCA Super Power UHF Pylon Antenna. Available Types: TFU-46AL, TFU-52-AM, TFU-60-AH. Signal Gain, 46, 52 and 60. The answer for economical 1-million watt operation.

Station-proved in daily commercial operation at WBRE-TV, the performance of RCA's 1-million watt UHF system is now an established record. Profit by RCA's engineering experience in high-power—and KNOW you've planned it right. Call your RCA Broadcast Sales Representative. In Canada, write RCA Victor Ltd., Montreal.

RCA Pioneered and Developed Compatible Color Television



RADIO CORPORATION of AMERICA
ENGINEERING PRODUCTS DIVISION
CAMDEN, N.J.

ONE MILLION WATTS

Super Power UHF a Reality

The new year at WBRE-TV, Wilkes-Barre, Pa., was heralded by the availability of one million watts of effective radiated power, making this pioneer UHF outlet the world's most powerful television station. First to operate with maximum power permitted by the FCC, the station broadcast its first million watt signal December 31, 1954 at 3:15 A.M. Megawatt program service was available to viewers within

WBRE-TV's extended service area that same day, New Years Eve.

This achievement was made possible by the development and production of the RCA super-power 25 kw UHF transmitter, TTU-25A and a super-power UHF pylon antenna, TFU-46AL, with a gain of nearly 50. The combination results in an effective radiated power of one million watts. Station-proved in daily operation at WBRE-

TV, the performance of this RCA combination is now an established record. Its operation is of special significance to UHF broadcasters everywhere because it has solved previous technical limitations opening the way to maximum power UHF broadcasting.

It has been "RCA all-the-way" for WBRE-TV as they have progressed to megawatt operation. The station first went

TTU-25A UHF AMPLIFIER

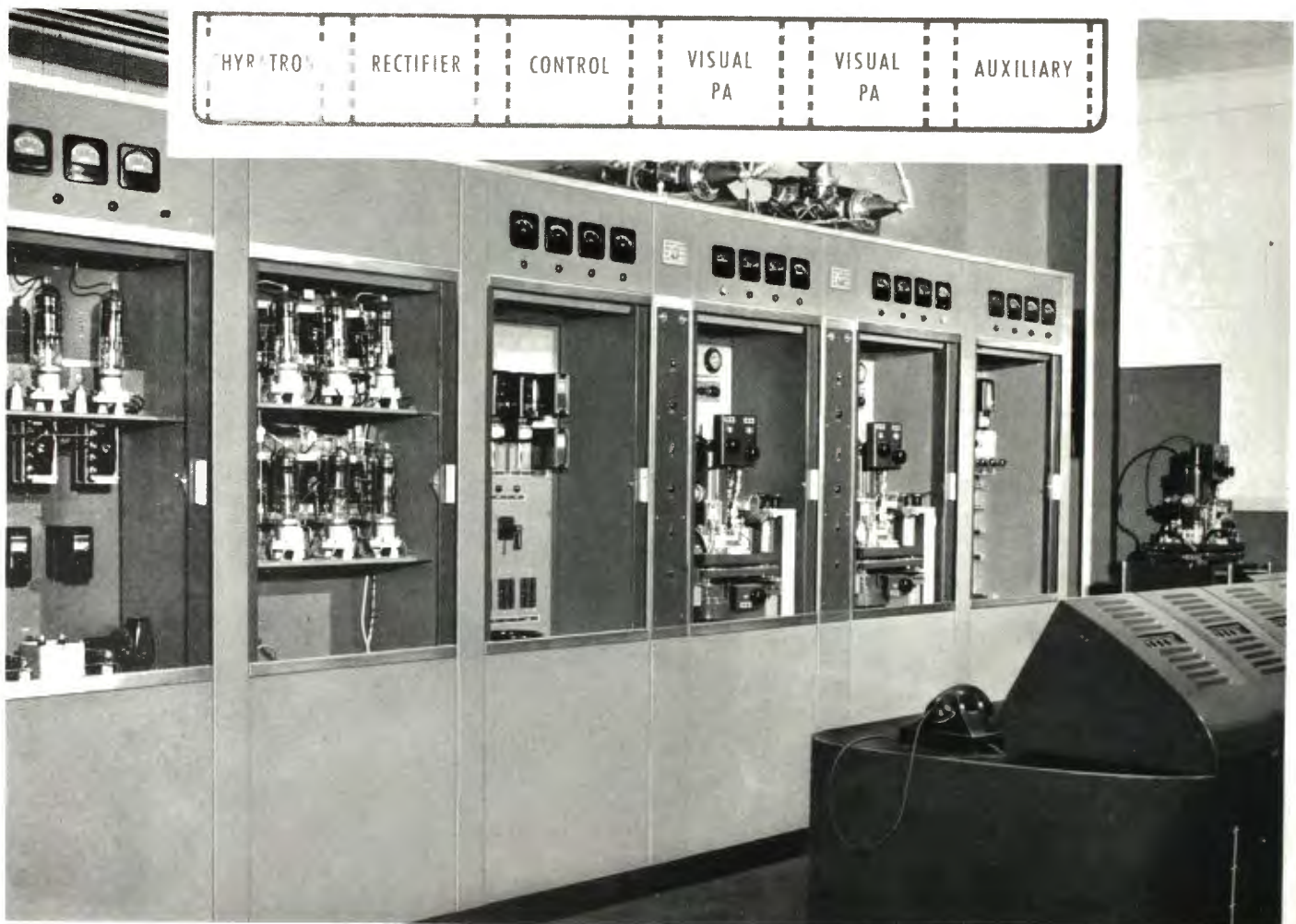

The 25 kw UHF Transmitter conversion as installed by WBRE-TV engineers. Pictured here are the control and visual P.A. cabinets. This amplifier group of cabinets has a power supply and cooling system independent of the driver chain (pictured on the right hand page) permitting ease of maintenance and cutback to 12 kilowatts.

"ON AIR" AT WBRE-TV

with RCA Megawatt Package

"on-air" with 17 kw ERP peak visual power obtained from the very first RCA TTU-1B 1-kw UHF Transmitter and RCA UHF Pylon on December 30, 1952. On July 31, 1954 they began programming with the first TTU-12A, 12½-kw amplifier which was added to their original TTU-1B. With the final addition of an RCA TTU-25A Amplifier the station has built-up to maximum power, replacing only

one item of their original equipment—their early UHF pylon antenna with the new RCA super-power design.

Each new power increase at WBRE-TV has been achieved without loss of air time. This is due for the most part to very careful advance planning. Plans for television operation were begun as early as 1947 when WBRE-FM was being constructed. With the guidance of RCA engineers, the

station planned the FM transmitter building to accommodate future television transmitter equipment. The FM tower was also designed to television requirements and was installed in 1947 at much less expense than an equivalent tower today. These early provisions have allowed the station to install their necessary new equipment with only minor building and tower modifications.

ORIGINAL TTU-12A TRANSMITTER



WBRE-TV's original TTU-12A Transmitter. The unit required slight modification in the aural P.A. so that this cabinet now provides the peak aural signal required for 25 kw operation. This transmitter serves as the driver chain for the amplifier pictured on the left hand page. Note that the TTU-1B is still an integral part of the new equipment.



One of the cabinets (left) of the TTU-25A Amplifier is placed in temporary packing for its short trip to Wilkes-Barre. Right, another cabinet gets a final check before shipment. The amplifier equipment is comprised of six individual sliding door cabinets of this type.

TTU-25 AMPLIFIER READIED AT CAMDEN

Very careful investigations of possible megawatt operation were being carried on in Camden as early as 1953. It became apparent that the RCA UHF Pylon design could be effectively utilized for extra high gains. The successful design, installation and operation of the TTU-12A Transmitter further encouraged this megawatt program. In August, 1954 a megawatt package comprised of a 25 KW UHF Transmitter and an ultragrain UHF Pylon Antenna was offered to the broadcast industry. In September WBRE-TV placed the first order for this equipment which has made them the first million watt TV station.

RCA production facilities at Camden immediately went into action. In October WBRE-TV's amplifier equipment was completed and testing operations began. In order to check out a complete 25 KW transmitter, two 12½ KW Amplifiers were individually tested on channel 28. These 12½ KW units were placed in adjacent test cages, and while these individual tests were being completed, the matching filter-



Packed and ready for shipment, the TTU-25A UHF Amplifier equipment is checked and signed off . . . destination WBRE-TV, Wilkes-Barre.

plexers and combining network equipment was connected and transmitter system tests began.

A complete TTU-25A UHF Transmitter is essentially two 12½ KW Amplifiers driven through a dividing network by an

existing TTU-12A Transmitter. The output of the driver is reduced to 5 kilowatts. Of this five kilowatt driving power, approximately 60% of the power (3 kilowatts) is deliberately thrown away in swamping loads at the input to the amplifier sections. This results in extremely stable and broadband operation with phase and bandwidth characteristics well within the limits required for color transmission.

The power supply, transformers, and cooling system of the amplifier are independent of those used for the TTU-12A driver. This allows for extra ease of maintenance and cutback to 12 KW of transmitter power.

Final tests on the new super-power amplifier were completed in November and the equipment was readied for shipment. Shipment was completed by November 24. Meanwhile the RCA antenna engineers were forging ahead full steam to complete the final link in WBRE-TV's megawatt installation.

WBRE-TV Chief Engineer, Charles Sakoski (right) checks over one of the RCA 6448 cavities with RCA transmitter engineer, M. W. Duris, who assisted with the installation.



HIGH POWER EQUIPMENT SET UP AT WBRE-TV

Installation of the new amplifier equipment began on Thanksgiving Day, 1954 and was completed with full power obtained from the transmitter in less than two weeks. The equipment and installation techniques were not new to WBRE-TV personnel for they had installed the first RCA 12½ KW Amplifier equipment only six months prior to this time.

From the beginning the station had carefully planned the transmitter layout to easily accommodate high power television equipment. Therefore their super power expansion found them with a more than adequate amount of floor space available.

The six amplifier cubicles were placed in the transmitter room along the wall opposite the station's TTU-12A transmitter. Both of these equipments are pictured on pages 6 and 7. A single supervisory console facing the TTU-12A is used for both. Its relative position in both pictures gives an indication of the transmitter room layout. At one end of the transmitter room is located the station's 1 KW FM Transmitter and at the other end are transmitter equipment cabinet racks (shown in the photo, lower right). Feed lines from the 25 KW Amplifier are run into an adjacent room, formerly a garage, where they are

connected to the station's twin filterplexers (see photo lower left). From the outputs of the filterplexers, sound and picture signals are fed to a combining network which in turn feeds a single 6½-inch transmission line run out to the tower and up to the antenna.

The amplifier and driver, as installed at WBRE-TV provides maximum protection and flexibility. A manual coaxial transfer panel permits emergency cutback to either one kilowatt or twelve kilowatts of transmitter power. Any of several dummy loads may be connected to this panel for test and alignment purposes.

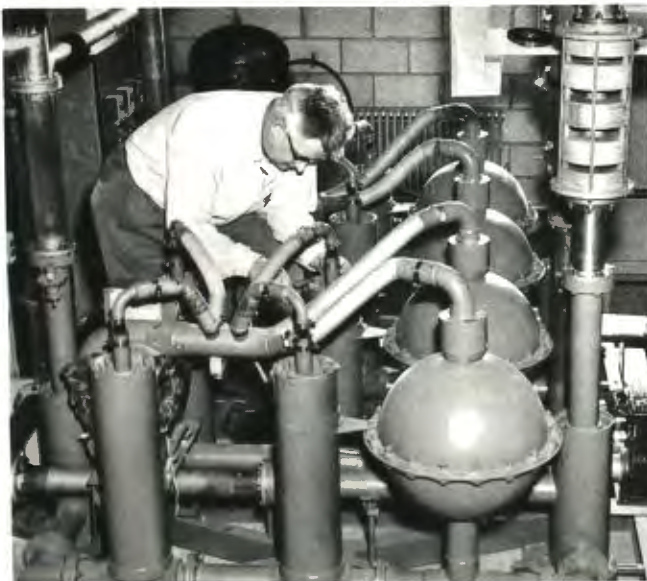

WBRE-TV's twin filterplexers. These were installed at the rear of a garage in the transmitter building. Sound and picture signal outputs are taken from the filterplexers and fed to a combining network. The output of the combining network feeds a single 6½-inch transmission line running out to the ultragrain UHF antenna.



View of the WBRE-TV transmitter room. Four of the TTU-25A Amplifier cubicles are shown at the right. The station's original TTU-12A transmitter (not shown) is placed parallel to these cubicles about six feet to the front of the supervisory console. Transmitter equipment cabinet racks are pictured at the far end of the transmitter room.

GIBBSBORO TEST SITE FOR ULTRAGAIN UHF ANTENNAS

Acceleration of an ultragrain antenna program and the requirements of new measurement techniques for these antennas demanded that RCA obtain an additional antenna test site. After searching southern New Jersey for possible locations which might provide excellent propagation characteristics, the new site was selected near Gibbsboro, New Jersey. The location included two hills spaced eight miles apart, covered with trees and underbrush. From one of the hills, 204 feet high, good line of sight propagation paths were obtained for a five mile radius. The site was leased on October 26, and that same night bulldozers moved in to cut out a road and clear the hill top. Grading was completed

November 8 and foundation for the turntable dug. Concrete for the turntable structure was poured two days later.

A new 15-ton turntable was necessary for ultragrain antennas because of their great weight and size. By the middle of November this giant turntable had been constructed, and the assembly of the drive mechanism and the wiring of turntable had begun. By the first of December the turntable was tested with temporary power, completing the job of providing measurement facilities.

Meanwhile several phases of antenna development were being carried on simultaneously. Single layer models were built for the 16-inch and 14-inch pipe and tested

for pattern information. A complete microwave model was constructed to obtain coupling and impedance data as well as gain information. All components were individually tested for their power handling capabilities. At the same time a full scale antenna was being fabricated.

By early December the two antenna sections were assembled for the first time and preliminary tests were taken. The assembled antenna was then hoisted on the new turntable and overall measurements begun. Working day and night, RCA Engineers directed their efforts toward obtaining the appropriate gain and pattern. This job was successfully completed on December 17 and the antenna shipped to WBRE-TV.

One section of the fabricated antenna is moved up a newly bulldozed road to the Gibbsboro site.





Using a specially designed harness puller, antenna workmen remove the harness for a very careful check before the two antenna sections are fitted together and raised to the 15-ton turntable for measurements.



WBRE-TV General Manager, David M. Baltimore and A. R. Hopkins, Manager RCA Broadcast Equipment Marketing, witness tests on the ultragrain antenna before delivery to the pioneer UHF outlet in Wilkes-Barre.



Messrs. Baltimore and Hopkins look over the drive mechanism for the 15-ton turntable. Remotely operated from the control and instrument shack shown below, the electric motor will drive the turntable from 1 to 5 rpm.



RCA engineers inspect the flanged joint at which the two sections of the ultragrain antenna have been assembled prior to hoisting the antenna on top of the turntable for pattern and gain measurements.

Rotation of the turntable is remotely controlled from the measurement shack. Equipment located here provides for immediate measurement of radiation pattern and power gain without need for manual integration methods. Outside workmen make adjustments prior to a measurement run.



ERECTION COMPLETED DESPITE ADVERSE WEATHER CONDITIONS

A cold thick mist enveloped the WBRE-TV transmitter site on the morning the antenna arrived. Roads leading to the site on a 2100-foot peak of Wyoming Mountain were covered with ice, and it was slow moving for the truck that had left Gibbsboro the evening before.

The two sections of antenna had been dismantled for shipping. The first job was to reassemble these sections, placing the antenna on horses near the tower base. Heaters had to be applied to the assembled antenna before ground measurements could be made to assure no damage had occurred

in transit. Snow and ice made these ground checks difficult and tedious. Data obtained in the ground check corresponded to that obtained before leaving Gibbsboro, and the antenna was ready for erection.

Snow, icing conditions and strong winds delayed the tower work for several days. On December 27 favorable weather conditions permitted hoisting of the antenna and dismantling of the top section of the tower.

Severe icing conditions prevented further tower work until December 30, when the new antenna was connected. The antenna,

which had been subjected to severe weather for many days with no power, required heating before the VSWR measurements could be made. Assured of adequate VSWR, power was gradually applied until a carrier of about 500 kilowatts was put on the air, and programming was sustained at this power. Operation continued until sign-off at midnight, at which time the shift was made to full 25 KW transmitter power.

The first one million watts of power was put on the air at 3:00 A.M. and programming was carried from 3:15 'til 9:00 A.M. on the morning of December 31, 1954.



Unloading and assembling operations proceed despite cold and rainy weather. Here the top section of the antenna is being lowered into place so that the complete antenna can be assembled for a ground check at the WBRE-TV site.



Top antenna section at the tower base. The weather has cleared, but the cold continues.



Top section is raised to be set inside the tower where it is joined to the bottom section.



Completely assembled ultragain Pylon is suspended in the center of the TV tower.

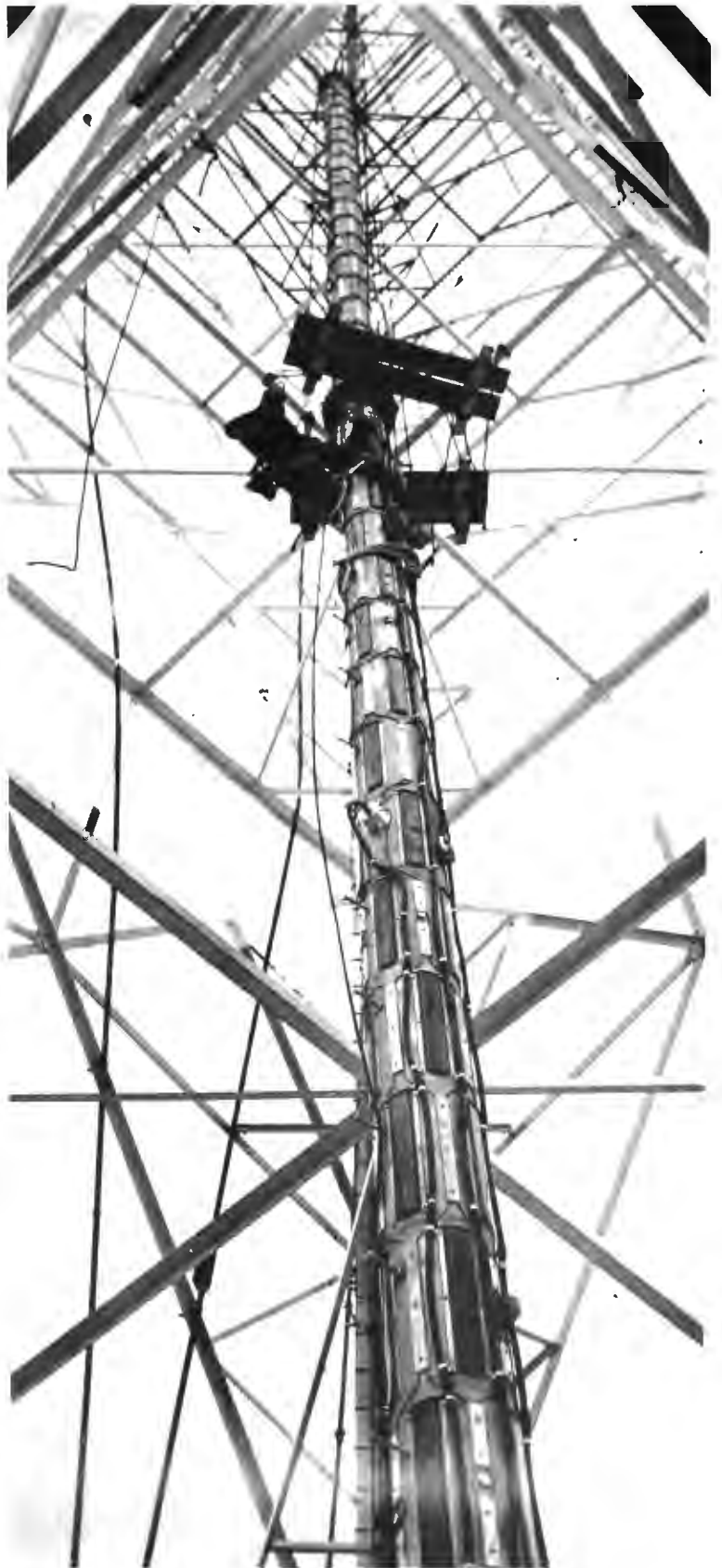

Finishing touches are made on flanged joint prior to lifting antenna to the top of the tower.

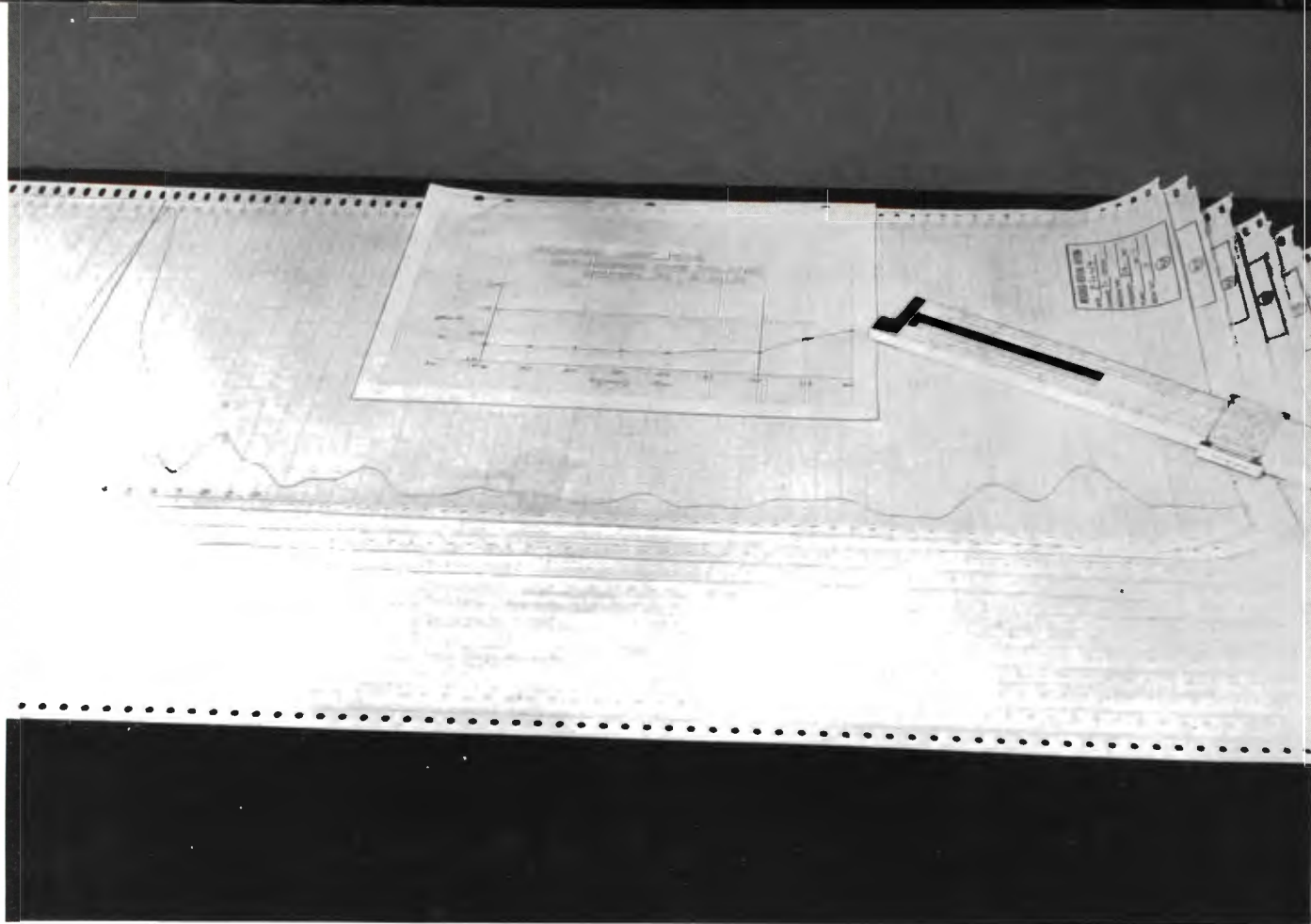

FIG. 1. Typical test data (photo of recording charts, horizontal pattern of directional antenna, VSWR vs. frequency plot).

PATTERN MEASUREMENTS OF RCA UHF TV ANTENNAS

By
E. H. SHIVELY*
 and
L. D. WETZEL*

Since all RCA UHF television Pylon antennas are now pattern tested and the results presented to the customer at the time of shipment of the antenna, this article is intended to outline the technical principles and measurement techniques and to demonstrate the great amount of antenna performance information available to the customer through RCA pattern testing facilities.

The pattern testing of a television broadcast antenna leads to two important results: (1) The radiation field intensity as a function of direction (radiation pattern) is measured and recorded; (2) The ratio of total radiated power from a dipole required to produce a given field intensity at a specified distance to the power radiated by the antenna when yielding equal maximum field at equal distance is measured. This is the directivity gain of the antenna.

Accordingly, the steps to be taken in pattern testing of a television broadcast antenna include:

1. Vertical field pattern of horizontally polarized radiation in sufficient num-

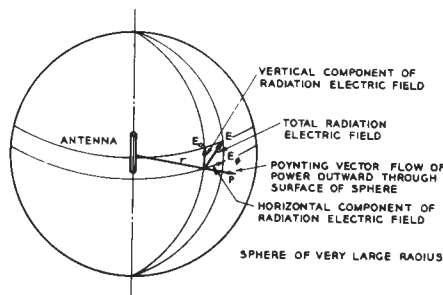

FIG. 2. Antenna in Imaginary Sphere.

- ber of vertical planes to define volume pattern.
2. Horizontal field pattern of horizontal polarization.
3. Power gain due to energy in horizontal polarization.
4. Reduction in power gain due to energy in vertical polarization.
5. Beam tilt.
6. Visual inspection of physical condition.
7. Measurement of input impedance at time of pattern test.

The only measurement omitted on the RCA UHF Pylons is the gain reduction due to vertically polarized radiation, since previous measurements have shown typical losses of 0.3 to .5%.

* Engineering Dept., Engineering Products Division, Radio Corporation of America.

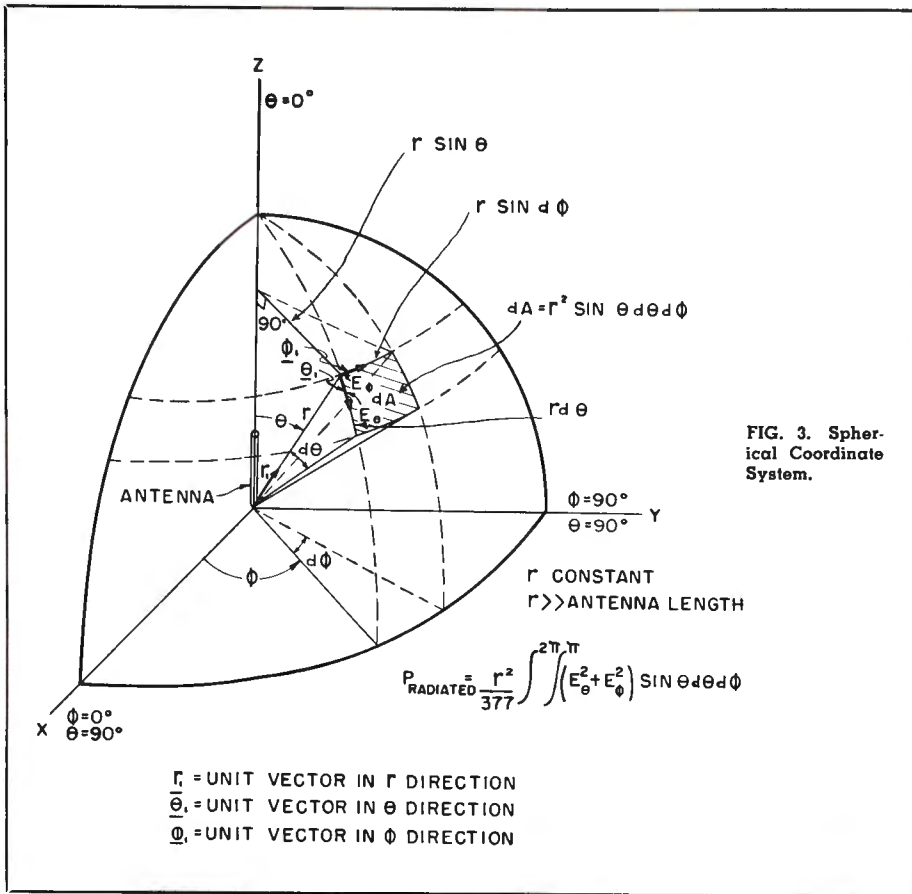

FIG. 3. Spherical Coordinate System.

The last step is a final check on the condition of the antenna before it leaves RCA on its way to the station. The customer and his designated consultant are invited to witness the pattern testing of the antenna before shipment. Typical test data is shown in Fig. 1.

The Basic Principle

Consider the antenna to be placed at the center of a sphere of radius large compared to the dimensions of the antenna, Fig. 2. The only electric field components contributing to radiated power are those tangential to the surface of the sphere, E_ϕ and E_θ . In the U. S. system of television transmission the polarization of the radiated field is horizontal, so that E_ϕ is the desired field and all vertical pattern measurements are plots of E_ϕ as a function of the vertical angle θ , Fig. 3. The cross-polarized component, E_θ , represents energy which contributes nothing to the received signal and thus is wasted, since in general E_ϕ and E_θ differ in time phase and result

in elliptical polarization of the total radiated wave.

The downward side of the vertical field pattern Fig. 4 is carefully shaped so as to follow an "ideal average pattern" which would give a signal strength constant throughout the coverage area and "rolling off" beyond. An accurate plot is thus essential in order to evaluate the coverage potential of the antenna. In the RCA pattern test system, the pattern is recorded on a wide strip chart in rectangular coordinates, from which a print is made directly and included as part of the test data.

All of the radiated power will flow through the surface of the sphere, and the surface integral of the radiated power density on the sphere will yield this total power. That is

$$W = \iint P \cdot ds$$

where P is the Poynting vector and ds is an increment of surface.

If then, a half-wave dipole is placed in the center of the sphere and the total radiated power adjusted so that the field intensity at the maximum point on the sphere is equal to the maximum field obtained with the unknown antenna, the gain of this unknown compared to the dipole will be:

$$\text{Gain} = \frac{W \text{ of dipole}}{W \text{ of unknown}} = \frac{\iint P_d \cdot ds}{\iint P_u \cdot ds}$$

The total radiated power of each antenna is obtained by integrating the power density over the surface of a sphere. In the case of the dipole, this can be calculated by analytic methods. The total radiated power of the unknown must be determined graphically, since it is related to the recorded pattern which is not readily expressible as an analytic function.

The spherical coordinate system is shown in Fig. 3. The incremental power radiated is that flowing through the area dA . In this system

$$dA = r^2 \sin \theta d\theta d\phi$$

and the total power is

$$W = \int_0^{2\pi} \int_0^\pi P(\theta, \phi) r^2 \sin \theta d\theta d\phi$$

Since $P = E \times H$, the normal component

$$\text{of } P = \frac{E_T^2}{n} = \frac{E_T^2}{377}$$

where E_T is the rms tangential component of the electric field on the surface of the

FIG. 4. Shaped vertical pattern.

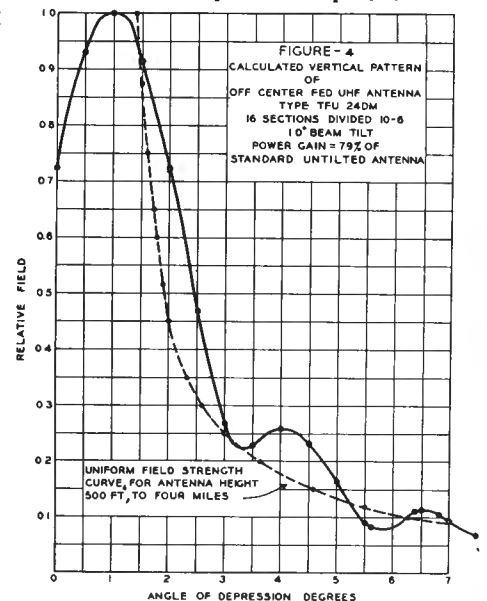

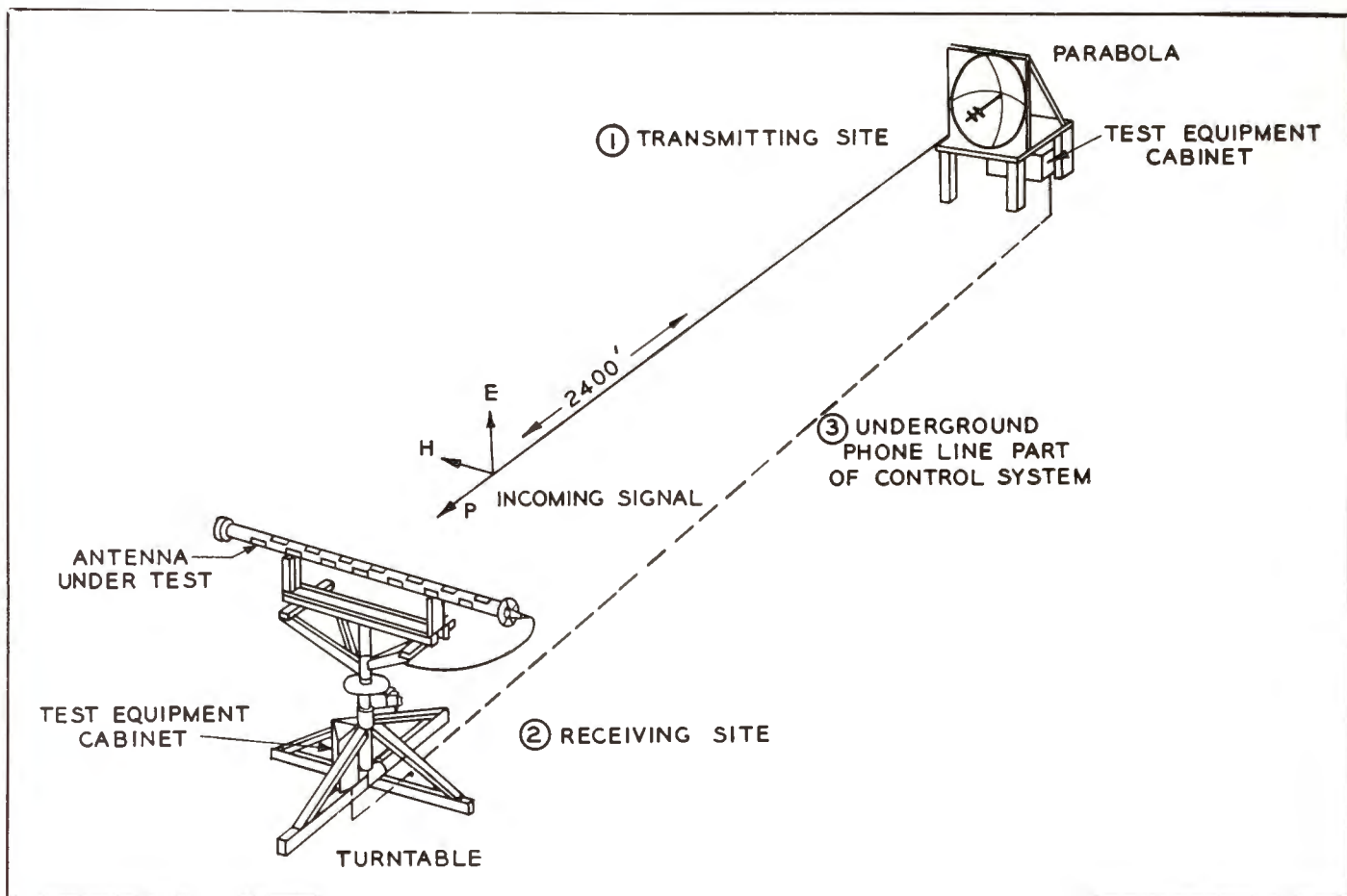

FIG. 5. Pictorial view of test site.

sphere and n is the intrinsic impedance of free space, 377 ohms.

Thus

$$W = \frac{r^2}{n} \int_0^{2\pi} \int_0^{\pi} E_T^2 \sin \theta \, d\theta \, d\phi$$

The total tangential electric field $E_T(\theta, \phi)$ is ordinarily determined by its components $E_\theta(\theta, \phi)$ and $E_\phi(\theta, \phi)$ which, by reference to Fig. 2, are the vertically and horizontally polarized components, respectively, so that

$$W = \frac{r^2}{n} \int_0^{2\pi} \int_0^{\pi} (E_\theta^2 + E_\phi^2) \sin \theta \, d\theta \, d\phi$$

For practical measurements, it is necessary to be able to express the definite integral of $E(\theta)$ as a function of ϕ . This is done by performing the integration with respect to θ for a number of values of ϕ and summing the results. Twelve equally spaced horizontal intervals are ordinarily measured, which gives sufficient accuracy for a directional

antenna and more than enough for an omni-directional. Thus

$$W = K \sum_{n=1}^N \int E\phi^2(\theta, \phi_n) \sin \theta \, d\theta$$

The cross-polarized component E_θ is neglected since previous measurements have shown that in the RCA Television Pylon

the power wasted in vertically polarized radiation is of the order of 0.3 to 0.5%.

The Practical Considerations

The radiated field intensity as a function of θ , the latitude angle, for any fixed ϕ , the longitude angle, Fig. 3, may be found by mounting the antenna horizontally on a turntable and rotating it while the radiated signal is received at a remote point. Due to the principle of reciprocity, the antenna may just as well be tested in receiving, and this is usually preferred, since the major quantity of test equipment is at the receiving location.

In order for the pattern to be accurately recorded, the chart of the recorder must be driven in synchronism with the antenna turntable. This is done at present by a selsyn link driven from a ring gear on the turntable shaft. The turntable must be rotated through a wide range of speeds by a power drive that permits velvet smoothness down to a mere crawl for accurate angular positioning.



FIG. 6. Transmitting site.

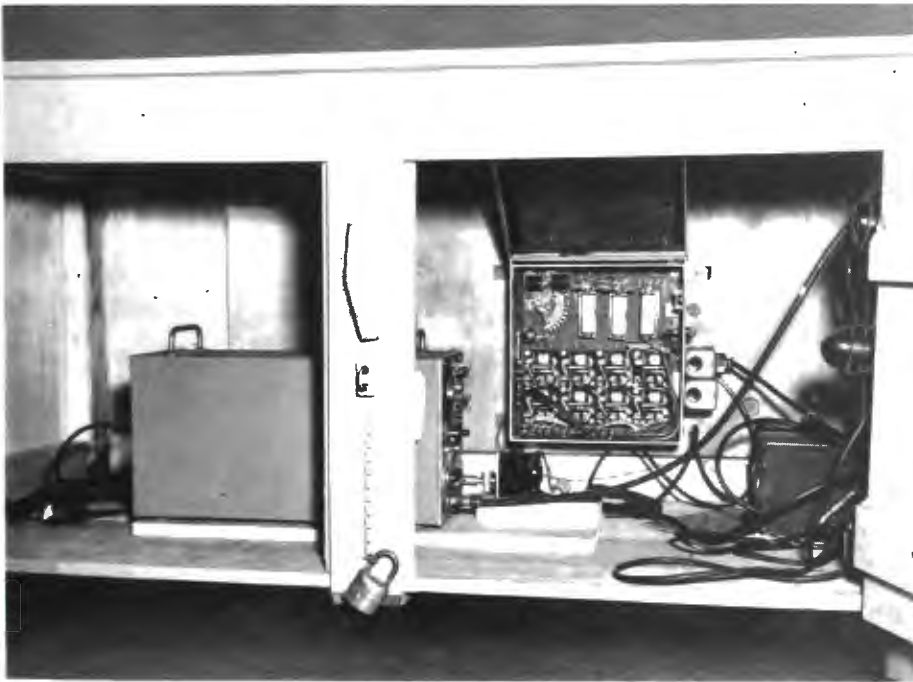

FIG. 7. Test equipment at the transmitting site.

The measured pattern data must be processed and the integrations of the preceding section performed. This is accomplished by an electronic computer at the turntable location which performs the mathematical operations as fast as the data is measured. The entire system must be

controlled from one point, which is the function of the telephone dial system.

The Pattern Test Site

The antenna test ground thus comprises (Fig. 5):

1. A transmitting site, from which the signal is beamed.

2. A receiving site at a distance, where the antenna under test is located, together with the turntable and associated test equipment.
3. A control system to link the transmitting and receiving sites so that operations may be carried on from one point.

At the transmitting site, Fig. 6, is located a high-gain parabolic antenna supplied by a signal generator housed in a cabinet under the platform. This enclosure is shown in Fig. 7 and contains, beside the oscillator, the telephone stepping equipment, the motors for oscillator control, a sound powered telephone handset, and a constant voltage transformer. The phone permits contact with the receiving site when it is occasionally necessary to do so.

The knobs are removed from the oscillator and small geared motors of high ratio are coupled to the shafts through friction clutches. In this way, the motors can drive the shafts to the limit of travel without damage to either. A similar motor rotates the dipole assembly in the parabola in order to change the plane of polarization of the transmitted signal remotely.

FIG. 8. UHF pattern test site.



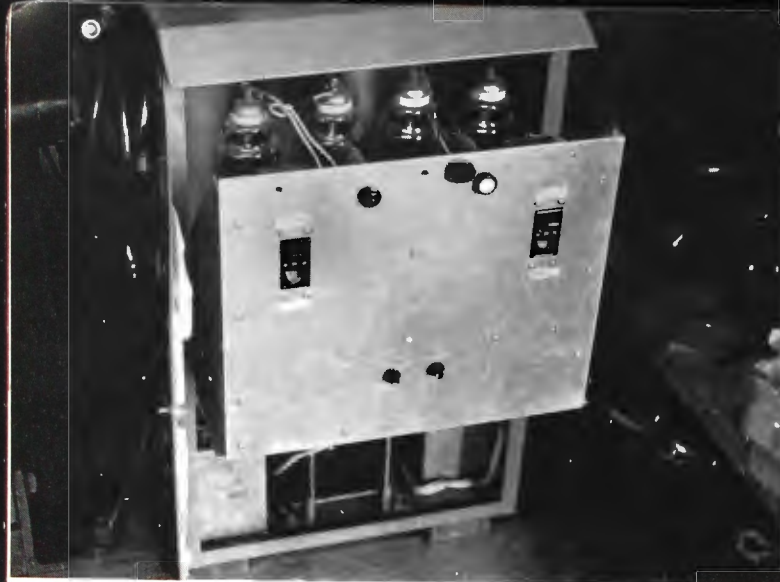

FIG. 9. Thyratron control.



FIG. 10. Test equipment.

The switching equipment (contained in the steel case with lid raised) is shown in Fig. 7. The system comprises a standard stepping switch (upper left in case) together with the necessary power and auxiliary relays. Ten operations may be performed independently by dialing the appropriate number at the receiving site. Two separate a-c power circuits and three motors may be controlled.

The receiving site, shown in Fig. 8, comprises a wooden framework turntable carrying the antenna in a horizontal position and provided with anti-friction bearings so that the upper half may be very easily rotated. Beneath the turntable is the equipment building which houses the motor drive, receiving gear and gain computer and

recorder. The turntable drive system is made up of a Reeves variable speed drive connected to a reducer which is chain coupled to the turntable. A 1/3 hp d-c motor drives this system which is controlled by a thyratron rectifier. (See Fig. 9.) This gives a continuously variable speed in either direction and plenty of torque since the system has a 5400 to 1 ratio.

The signal from the antenna is received on an RCA BW-3A UHF field intensity meter. The d-c voltage output from the recorder jack is fed to the strip recorder for field patterns and to the computer for gain measurements. (See Fig. 10.) The chart for the strip recorder is driven by the receiving selsyn according to informa-

tion from the transmitting selsyn geared to the turntable spindle. The angular position of the antenna thus automatically positions the chart. The angle may also be read directly on a compass rose which is mounted on the turntable spindle and is provided with a vernier to permit angular readings to be taken to within $\pm 0.1^\circ$.

A frequency meter is provided to check the oscillator frequency. The cable is removed from the BW-3A and connected to the frequency meter and the oscillator frequency at the transmitting site is adjusted through the dial system.

To facilitate handling of the UHF Pylon antennas, a 5-ton crane was recently added to the test site equipment as shown in Fig. 11. A small machine shop was also added to speed up development work which is also done at this test site.

A surveyors transit is used to check the angular accuracy of the selsyn system and compass rose at frequent intervals.

The Test Procedure

In taking a pattern, the antenna is turned approximately broadside to the incoming signal and the cable connected to a frequency meter. The oscillator frequency is then set to the desired value by dialing the appropriate numbers.

With the cable connected to the field intensity equipment and the antenna rotated until maximum signal is obtained, the correct gain and zero adjustments are made on the equipment. At this point a check is made on the linearity of the system by feeding the output of a signal generator, with an attenuator calibrated in decibels

FIG. 11. Crane in operation.



or microvolts, into the receiver and adjusting the attenuator so that the signal matches the maximum signal from antenna input to the receiver. Now the signal from the generator is attenuated and adjustments are made until the recorder tracks the signal output of the generator.

The antenna is returned to zero (axis pointing at the transmitter) by means of the large compass rose and vernier. After exciting the selsyns and setting the recorder chart so the pen is on a main division, the run is begun. At this time, any aircraft in the vicinity of the airport invariably decide to land. Since the transmitted beam crosses the runway, an anomalous pulse is applied to the pattern which is marked and discounted later. The same effect which started radar development operates here also.

In development work it is always necessary to check the power wasted in cross-polarized radiation in a new antenna. For this test, a small dipole, isolated from the re-radiated field of the main antenna by a metal reflecting sheet, is set up on the turntable and oriented parallel to the main antenna's normal radiation. The received field strength is read in relative units to give E_θ .

The transmitting dipole is then rotated by the dial system until a null occurs, at which time the incoming signal is a plane wave with electric field perpendicular to the receiving dipole axis. Then, the receiving dipole is positioned for maximum signal and this read in relative units to give E_θ . Since the transmitter power output is the same in both cases, the relative transmission coefficient is $\frac{E_\theta}{E_\phi}$.

Electrical beam tilt is checked by rotating the antenna through two main beams or 360° and measuring the distance on the chart between these beams. This distance should be 180° for 0° tilt and twice the beam tilt more or less than 180° depending upon which set of beams is chosen.

After measuring field patterns, the receiver is connected to the gain computer instead of the recorder. Linearity of this system is checked in a procedure similar to the linearity check for voltage except

that a voltmeter is substituted at the output of the multiplier circuit. Since the gain computer measures power, the reading on the voltmeter will be the square of the previous readings for a similar amount of attenuation.

With the system adjusted to give linear results, the antenna is rotated through 180° and the integrated voltage (equivalent to the area under a power plot) is read on a meter. This value is compared to the value for an isotrope to give the gain of the measured antenna. Twelve such runs are made in the same planes as were used in making the field patterns and an average is used as the gain of the antenna. This method is used for standard antennas but considerably more runs are made on a directional antenna and the gain is arrived at by taking into consideration the horizontal pattern.

Computation of Gain

Since the total radiated power of the antenna may be thought of as a summation, we will first deal with the process of forming the integral under the summation sign and then discuss the summation of blocks of power.

The output voltage of the receiver, proportional to E_θ is fed into a squaring amplifier, then applied to the terminals of a sinusoidal potentiometer geared to the turntable on a one-to-one basis, producing

$$E_\theta^2(\theta) \sin \theta$$

This signal is then amplified and used to excite a tachometer generator also geared to the turntable. The output of the tachometer generator is

$$K \frac{d\theta}{dt}$$

This is then fed into a standard RC feedback integrator and integrated with respect to time so that

$$W = \frac{-K}{RC} \int_0^T E_\theta^2(\theta) \sin \theta \frac{d\theta}{dt} dt =$$

$$\frac{-K}{RC} \int_0^{\theta_0} E_\theta^2(\theta) \sin \theta d\theta$$

A voltage proportional to the power radiated in that sector of the imaginary sphere surrounding the antenna is read directly



FIG. 12. Computer rack.

on an indicating instrument as soon as the pattern is taken. The gain is then

$$\text{Power Gain} = \frac{C}{\sum_{n=1}^N \int_0^\pi E_\theta^2(\theta, \phi_n) \sin \theta d\theta}$$

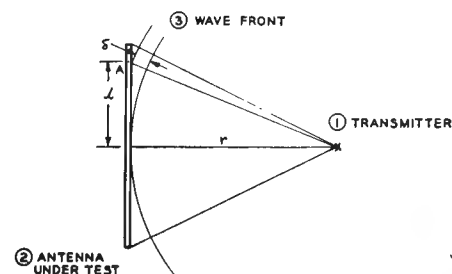

FIG. 13. Geometry of Path-Length Difference.

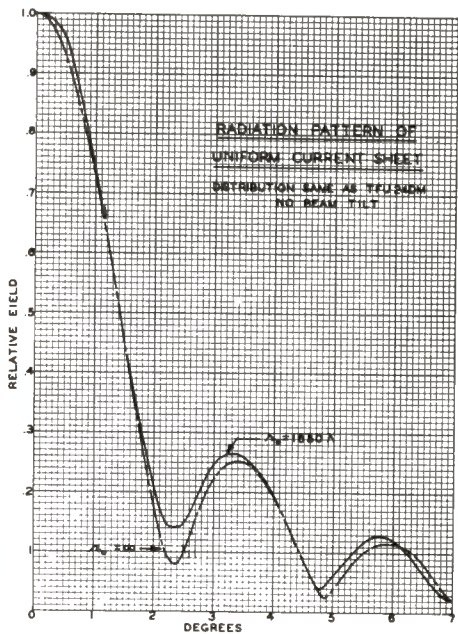

FIG. 14. Radiation pattern of uniform current sheet (no beam tilt).

The pattern recorder and gain computing circuits are incorporated in one standard relay rack which includes all power supplies, switches for the selsyns, a small test oscilloscope, exhaust blower and spun glass air filters; the unit is shown in Fig. 12.

Fresnel Zone Effects

Since all pattern calculations are made on the basis of parallel rays from the vari-

ous elements of the antenna, the transmitting site should be at infinite distance from the receiving site. Obviously, the best compromise is to separate the sites as far as possible and then make allowances for discrepancies in the pattern due to the departure from a plane wave front as the wave arrives at the antenna. These discrepancies are caused by the currents at the various layers differing slightly in phase along the aperture.

This is shown in Fig. 13, wherein the wave front from the transmitting site is assumed to be spherical. In this case, the separation distance is r , the antenna aperture is a , and the distance from antenna center to any point A is l . The phase error, or time relay distance δ , at A is for $l \ll r$

$$\delta = \frac{l^2}{2r}$$

$$= \frac{360 l^2}{2r\lambda}$$

Thus, the phase variation along the array due to finite separation may be calculated, and this variation used to predict the amount of null fill-in to be expected.

In a previous article, the effects of phase variations on an otherwise uniform array were calculated by a Fourier Series approach. With the introduction of special array illuminations for null fill, the prob-

lem is better attacked through continuous distributions of sources and the Fourier Integral.

Duhamel, of the RCA Laboratories, showed how the effect of a square law phase error on the pattern of a uniform current sheet could be calculated using tables of Fresnel Integrals. The writers extended this to the nonuniform illumination used in the RCA Television Pylon and calculated typical patterns, Fig. 14 and Fig. 15 for those conditions encountered at the Medford, N. J. test site. Note that the effect of Fresnel diffraction may either augment or lessen the null fill.

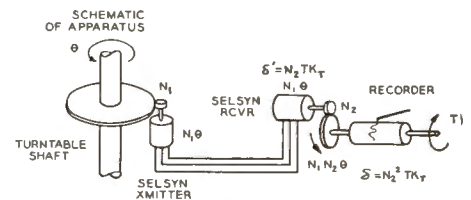

FIG. 16. Recorder drive system.

Recording System Accuracy

With high gain antennas having half-power beam widths in the order of 2 degrees, the recording accuracy requirements become quite critical, especially when it is necessary to measure beam tilts. In this particular application, it is necessary to be able to record to within $\pm 0.1^\circ$.

FIG. 15. Radiation pattern of uniform current sheet (1° beam tilt).

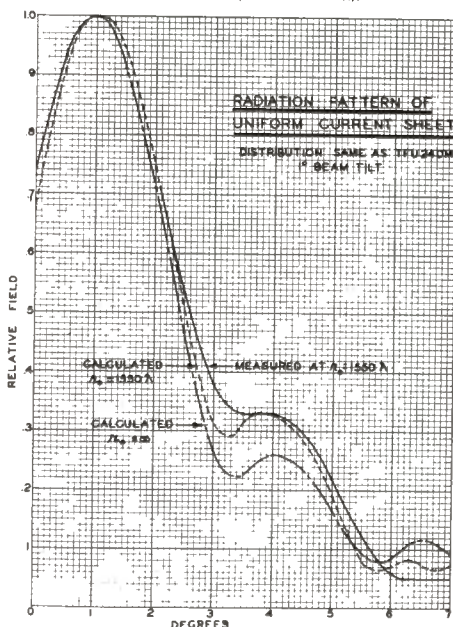
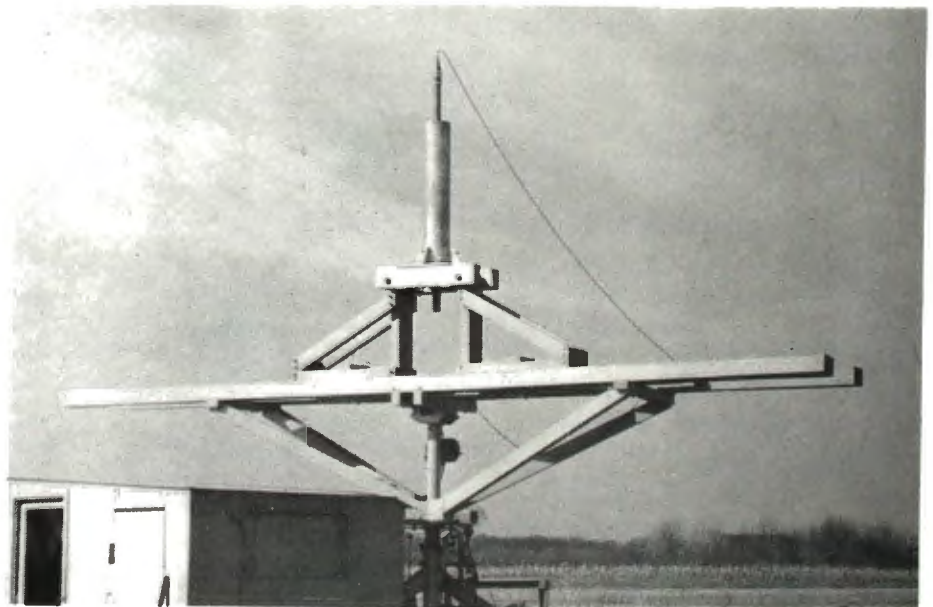

FIG. 17. Horizontal pattern measurement.



With the recording of narrow beams, it is necessary to "spread out" the chart, i.e., make each degree of turntable rotation equal to a considerable space on the chart. In the test here described, one degree equals $\frac{1}{2}$ inch of chart. At these low gear ratios between selsyn and recorder, the input frictional torque supplied by the selsyn is considerable and the machine will drop behind its theoretical angular position until it develops sufficient torque to pick up the load. The gear ratio equations by which correct ratios are chosen have been discussed in BROADCAST NEWS, Vol. No. 69, May-June, 1952, Pg. 47.

Many quantities not ordinarily considered assume prime importance. For example, some elastic angular deflection of the turntable and shaft will appear between antenna and bearings due to the bearing frictional torque, since the turntable is rotated by torque applied to the bottom of the rotating members. Because the selsyn must be mounted on a fixed support, its position is necessarily at the top bearing, and it will read the position of the shaft at that point with respect to the bearing.

The actual position of the antenna deviates from this due to the elastic angular

deflection, and thus the antenna and its pattern (which appears at the pen) are ahead of the chart; consequently, a recording error results.

This effect is complicated by the fact that the bearing (on which the selsyn is mounted) itself is constrained by the elasticity of the mounting timbers, so that as force is applied to the top of the turntable and the antenna begins to rotate, first the lower bearing then the shaft and timbers at the top twist until the static bearing friction is exceeded, thus putting the antenna further ahead of the chart.

The effects are exaggerated in this description, being in the order of 3 to 5 minutes of arc; nevertheless, they do affect the results. The deflection of the bearing mounts has been measured by mounting a mirror on the bearing and sighting a transit on a distant object. Torque is applied until the turntable is on the verge of rotation, and the movement of the object measured in minutes of arc. If the transit shows θ minutes, the bearing rotates $\frac{\theta}{2}$ minutes.

An overall test of the system is made periodically. A transit is set up on the turntable beside the center of the antenna and a push button arranged in a circuit to apply a voltage pulse to the recorder. The transit is first sighted on the center of the transmitting parabola, 2400 feet away, and the recorder set on a main chart division. Then, as the turntable is slowly rotated, an observer sets the transit ahead by ten degrees, locks it down, and waits for the cross-hairs to reach the center of the parabola. As they cross, the button is pushed and a pulse appears on the recorder. Enough readings are taken to average out the human errors.

Special Tests

The pattern test setup is used for research and development work also. Some of the special projects have been on model antennas and single layer antennas, effect of mounting two antennas side by side, and effect of mounting an antenna inside a tower. Special designs for VHF antennas are built up in scale models and checked for pattern and gain.



FIG. 19. Typical measured vertical pattern.

The horizontal patterns of the UHF directional antennas are measured by using a single layer antenna and mounting it vertically on the turntable, as in Fig. 16.

A six layer antenna was used to determine the effect of two antennas mounted side by side and separated by several distances and also the effect of mounting the antenna within the tower as shown in Fig. 17 was explored.

The process of antenna pattern measurement is continually undergoing changes in the direction of higher accuracy and greater speed; and this naturally points the way to increased mechanization. Effort, at the present time, is being directed along these lines in order to yield measurements of greater accuracy—faster.

Acknowledgment

Appreciation is expressed to O. O. Fiet and D. C. Stock of the Broadcast Antenna Engineering Section for their participation in the development of the antenna gain computer and for helpful comments in the presentation.

Bibliography

- E. H. SHIVELY, "Pattern-Testing the TFU-24B UHF Antenna," BROADCAST NEWS, Vol. No. 69, May-June, 1952, pp. 44-51.
- O. O. FIET, "A New UHF Television Antenna, TFU-24B," BROADCAST NEWS, Vol. No. 68, March-April, 1952, pp. 8-23.
- J. D. KRAUS, "Antennas," McGraw-Hill Book Company, 1950, p. 99.
- J. R. CARSON, "A Generalization of the Reciprocal Theorem," Bell System Technical Journal, 3, July, 1924, pp. 393-399.

FIG. 18. Tower interference test.



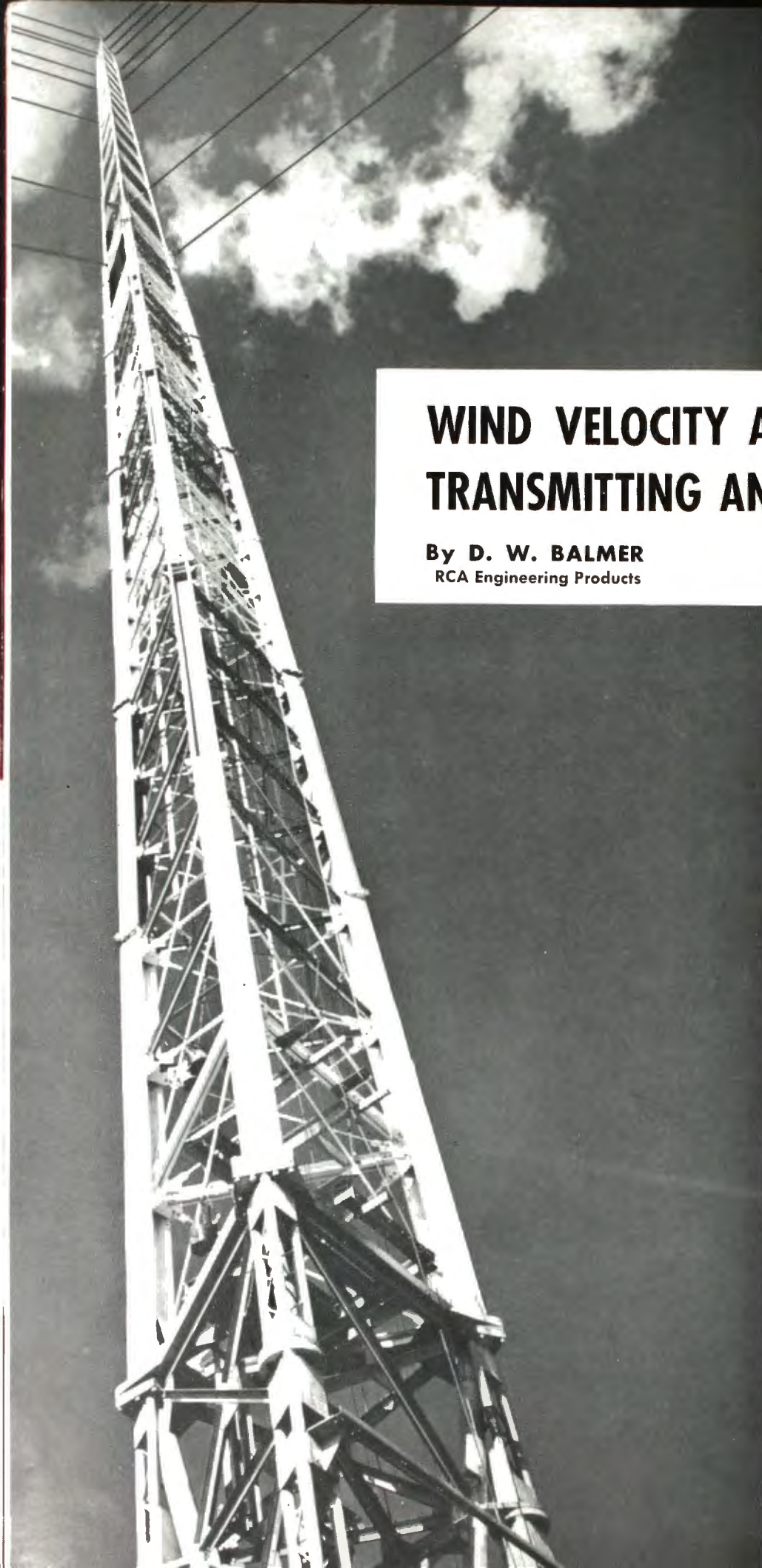

FIG. 1. A massive Ideco structure at KWTV, Oklahoma City. 1572 feet high, 2,800,000 pound working load supported by a base insulator made up of 21 four-inch diameter porcelain tubes with a crushing strength of over 11,000,000 pounds, 1,300,000 pounds of structural steel, 50 tons of bolts, over 5 miles of guy cables, 40# wind load up to the 780' level and 60# wind load above the 780' level.

WIND VELOCITY AND ITS EFFECT ON TRANSMITTING ANTENNAS & TOWERS

By **D. W. BALMER**
RCA Engineering Products

During the past few years there has been an apparent increase in winds of high velocity throughout the United States. Coupled with this there has been wider dissemination of information on storms and hurricanes. This has increased public consciousness of the potential dangers and a tightening of requirements (especially with respect to wind velocity) is now being considered.

The greater amount of meteorological information available and the wider publicity given to the occurrence of damaging winds has been responsible for changes in tower design. The installation of taller transmitting antenna towers has also been a factor.

The following article has been written to aid station management and engineering personnel in acquainting themselves with the latest information on wind data, design criteria, and velocity requirements.

Wind Velocity Measurements

In designing antennas or towers to withstand high winds, some difficulty is experienced in determining the maximum velocities to which the structure will be exposed. Published records of the U. S. Weather Bureau are given as "maximum" (5 minute average velocity) or "extreme" (the speed of the fastest mile of air passing the anemometer). Studies made of records from 52 cities throughout the U. S. seem to show that extreme speeds are approximately 1.2 times the maximum speeds.

Instantaneous gusts and sustained strong winds have considerable bearing on design considerations since the period of vibration of most structures or parts of structures is less than a few seconds. The impact of a severe gust may impose a greater load on a structure already strained by a strong steady wind than it would when the gen-

eral wind is lighter. It is apparent from studied records that strongest gusts are about 1.4 times the extreme wind (fastest mile). The variation of wind velocity with height is also of great importance as a design factor. Considerable research has been done on the subject by R. H. Sherlock and others, with varying results.

When the records of an individual locality are examined it is usually found that winds of high velocity occur very infrequently, except at locations exposed to sea such as Cape Hatteras, etc.

Winds are rarely steady . . . they fluctuate from second to second by appreciable amounts. While the speed for a fraction of a second can be measured by laboratory equipment, conventional instruments are used to determine speeds for a period of seconds or minutes. Wind speed is usually measured either by the rate of motion imparted to a freely rotating mechanism, by the pressure effect, or by the cooling effect on an electrical thermocouple junction.

Prior to 1928, the official U. S. Weather Bureau instrument was the Robinson-type anemometer with a 4-cup driving unit. The readings of this instrument were usually published without correction and were known as indicated velocities. Due to the large errors of the instrument at high speeds a change was made in 1928 to a 3-cup unit which had smaller errors. Since 1932, corrections for instrumental errors have been applied to the data before publication, and no single type of instrument was considered standard. Most weather bureau stations are now equipped with triple register anemometers that record wind velocity, wind direction, and amount of sunshine.

Anemometers of the pressure type do not indicate wind passage, they indicate instantaneous speeds. These are actually averages for about one second. In laboratory type instruments the intervals may be much smaller. The Dines anemometer measures the difference between pressures in tubes opening into and across the wind. Another type measures the pressure by torque effect applied to a set of cups mounted on a horizontal wheel bridled by a spring, known as a bridled cup anemometer. A later instrument design records the cooling effect of a heated thermocouple and will operate even during severe icing conditions.

Wind Conditions

A study of wind conditions recorded by the U. S. Weather Bureau indicates a wide distribution over the country of high velocity occurrence. The vast area and topo-

graphic diversity of the country provides a good example of wind conditions in the middle latitudes. These are among the windiest in the world.

While these velocities vary considerably throughout the country they usually vary through the year in a somewhat constant pattern. In the Eastern states the highest "extremes" have been recorded in September and March and in the Gulf states during September. The Central states have had a wide distribution of "extremes", mostly from March to June. The Mountain states have recorded highest winds in January, while in the Pacific states December and January are the windiest. The Atlantic coastal cities have experienced considerably higher "extreme" wind speeds than have the Pacific. Boston has recorded 87 mph, Providence 95, New York 113, Atlantic City 91, Savannah 90 and Miami 132.

The highest wind velocity ever recorded in the U. S. was at the observatory atop Mt. Washington, New Hampshire, 6283 feet above sea level. Here on April 12, 1934 a wind velocity of 231 mph was registered. At Blue Hill observatory in Massachusetts an extreme speed of 186 mph was recorded during the hurricane of 1938. There seems to be no adequate reason for exempting any locality in the U. S. from the probability of sometime experiencing actual wind velocities of 80 to 90 mph.

The strongest winds in the world are those of tornadoes which are most common in central North America. The width of their path in most cases is only 15 to 100 yards, occasionally a mile, and the length 10 to 15 miles. Even in the heart of the tornado region, which extends from northeastern Oklahoma to northern Iowa, the chances are slight that a tornado will strike. The problem, however, of withstanding the full force of a tornado is so great that such winds can hardly be considered in tower design.

Hurricanes are cyclonic storms¹ that develop in the tropics and move northward or southward into the temperate zones. Cyclones of the north Atlantic are called hurricanes while those of the Pacific are known as typhoons. The most destructive hurricanes that affect the U. S. are those originating in the vicinity of the West Indies. They sometimes follow a path across the Gulf of Mexico westward to the

¹ A storm or system of winds, often violent in the tropics but moderate elsewhere, with abundant precipitation and usually a diameter of 50 to 90 miles.

FIG. 2. WKZO, Kalamazoo, Michigan.
40# wind load.

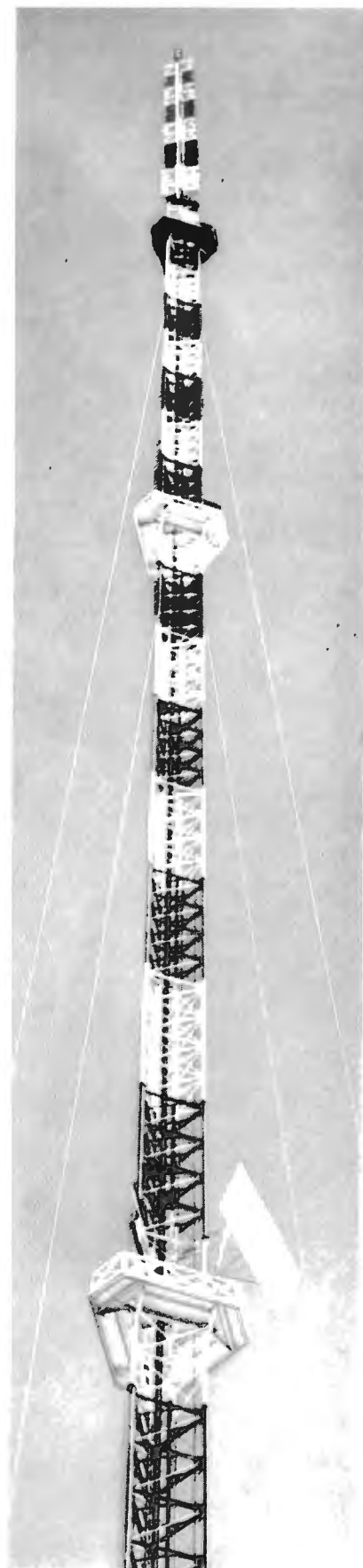

mainland, or toward the Gulf states where they soon dissipate inland forming extra tropical lows. At other times they follow a path across the Bahamas toward the east coast, then veer northeastward to the Atlantic. This steering effect is probably due to wind flow at an elevation of ten to twenty thousand feet. The behavior of Atlantic hurricanes in the past few years, however, is evidence that the entire Eastern seaboard is vulnerable to their effect.

Local topographical features such as abrupt hills, ridges, or mountains have a profound influence on wind velocity. A condition known as the venturi effect is responsible for greatly increased wind velocities at the ridge or summit when wind blows up the side of the slope. A study of profiles in various directions will indicate the degree of this effect.

It is quite evident from the foregoing discussion that all proposed tower installations should be carefully checked as to local wind conditions. A thorough study of

the area should be undertaken before design assumptions are agreed upon.

Design Conditions

Wind velocity pressure is defined as the pressure against a square foot of surface perpendicular to the wind direction, representing the kinetic energy of moving air. The wind pressure to be expected on a structure is influenced by geographical location, height above ground, and exposure.

Design wind pressure which should not be confused with velocity pressure, is the product of the actual pressure of wind on a square foot of surface, and a shape coefficient determined by the geometrical form of the structure and other considerations.

The velocity pressure formula

$$P = .00256 V^2 \text{ where } P = \text{pressure in pounds per sq. ft. and } V = \text{velocity in miles per hour.}$$

is derived from the basic statement of kinetic energy of a moving mass.

$P = \frac{1}{2}MV^2$ where P = pressure per unit area, M = mass per unit volume, which in the case of air under standard conditions is

$$\frac{.0763}{32.3} = .00237 \text{ lbs. per cu. ft., and}$$

V is velocity of mass in feet per second.

$$\therefore P = \frac{1}{2} \times .00237 V^2 = .00118 V^2$$

which may be converted to miles per hour by multiplying by $\left(\frac{5280}{60 \times 60}\right)^2$

or by 2.16 thus: $P = .0018 \times 2.16 V^2 = .00256 V^2$ where P is lbs. per sq. ft. and V is velocity in M.P.H.

The design pressure is found by multiplying the velocity pressure by a correction for gusts and by a shape factor. Using averaged values the formula becomes

$$P = .00256 V^2 \times 1.25 \text{ (gust factor)} \times 1.3 \text{ (shape factor)}$$

thus the design pressure for a wind velocity of 100 miles per hour would be 42 lbs. per square foot. This value can then be used in the formula for flat surfaces $P = .0042 V^2$.

A relation exists between the pressure on a flat surface and pressure on a round surface having the same projected area and is determined by wind tunnel tests and tests in natural winds. The Radio-Electronics-Television Manufacturers Association uses a 2/3 factor, which is considered standard for all radio and television towers, while the American Standards Association and National Bureau of Standards uses 0.60. The chart in Fig. 3 shows wind velocities and corresponding design pressures based on both RETMA and ASA requirements. There is a move underway to standardize the various flat to round relationships.

After the design pressure has been established, the wind load is determined for the structure to be designed. This is accomplished by finding the total projected area (Fig. 4a and 4b) in square feet of all the members and multiplying this figure by the wind pressure in pounds per square foot.

The effect of ice on antennas and towers must be carefully considered. Some building codes specify the amount of radial ice that must be used in the design. The Los Angeles county building code, for example, requires that the design be based on 30 pounds per square foot of projected area plus 2 inches of radial ice. In figuring the total projected area, the effect of ice is added as shown in Fig. 4a. In the case of superturnstile antennas the projected area

TRUE "EXTREME" VELOCITY MILES PER HOUR (NOTE No. 1)	WIND VELOCITIES & CORRESPONDING PRESSURES				INDICATED VELOCITY MILES PER HOUR (NOTE No. 2)
	FLAT SURFACES PRESSURE IN LBS. SQ. FT. OF PROJECTED AREA		CYLINDRICAL SURFACES PRESSURE IN LBS. SQ. FT. OF PROJECTED AREA		
	ASA	RETMA	ASA	RETMA	
V_1	$P = .0042 V_1^2$	$P = .0042 V_1^2$	$P = .0025 V_1^2$	$P = .0025 V_1^2$	V_2
10	.42	.4	.25	.26	11
15	.95	.9	.56	.58	17
20	1.7	1.6	1.00	1.0	23
25	2.6	2.5	1.6	1.6	30
30	3.8	3.6	2.3	2.3	37
35	5.2	4.9	3.1	3.2	44
40	6.7	6.4	4.0	4.2	50
45	8.5	8.1	5.1	5.3	57
50	10.5	10.0	6.3	6.6	64
55	12.7	12.1	7.6	7.3	71
60	15.1	14.4	9.0	9.5	78
65	17.8	16.9	10.6	11.2	85
70	20.6	19.6	12.3	12.9	91
75	23.6	22.5	14.1	14.9	98
80	26.9	25.6	16.0	17.0	105
85	30.4	28.9	18.1	19.0	112
90	34.0	32.4	20.3	21.4	118
95	37.9	36.1	22.6	23.8	125
100	42.0	40.0	25.0	26.4	132
105	46.3	44.1	27.6	29.1	138
110	50.8	48.4	30.3	31.9	145
115	55.5	52.9	33.1	34.9	152
120	60.5	57.6	36.0	38.0	159
125	65.6	62.5	39.1	41.3	166
130	70.9	67.6	42.3	44.6	173
135	76.5	72.9	45.6	48.1	180
140	82.3	78.4	49.0	51.7	187
145	88.3	84.1	52.6	55.5	194
150	94.5	90.0	56.3	59.4	201
155	100.9	96.1	60.1	63.4	208
160	107.5	102.4	64.0	67.6	215
165	114.3	108.9	68.1	71.7	222
170	121.4	115.6	72.3	76.3	229
175	128.6	122.5	76.6	80.9	236
180	136.1	129.6	81.0	85.5	243
185	143.7	136.9	85.6	90.4	250
190	151.6	144.4	90.3	95.3	257
195	159.7	152.1	95.1	100.4	264
200	168.0	160.0	100.0	105.6	271

THESE FIGURES ARE NOT SUBSTITUTED BY ACTUAL TESTS BUT ARE ESTIMATED

NOTE No. 1—Since 1932 published weather data based on 5 minute average known as "Maximum" and frequently an fastest mile known as "Extreme." Selection of antenna loads should be based on Extreme (increase "Maximum" by 25% if no data on Extreme).

NOTE No. 2—RCA bases strength of antennas on True Velocities, not Indicated. Indicated Velocities are those given by the Robinson 4 Cup Anemometer (now obsolete).

FIG. 3. Chart showing wind velocities and corresponding design pressures based on both RETMA and ASA requirements.

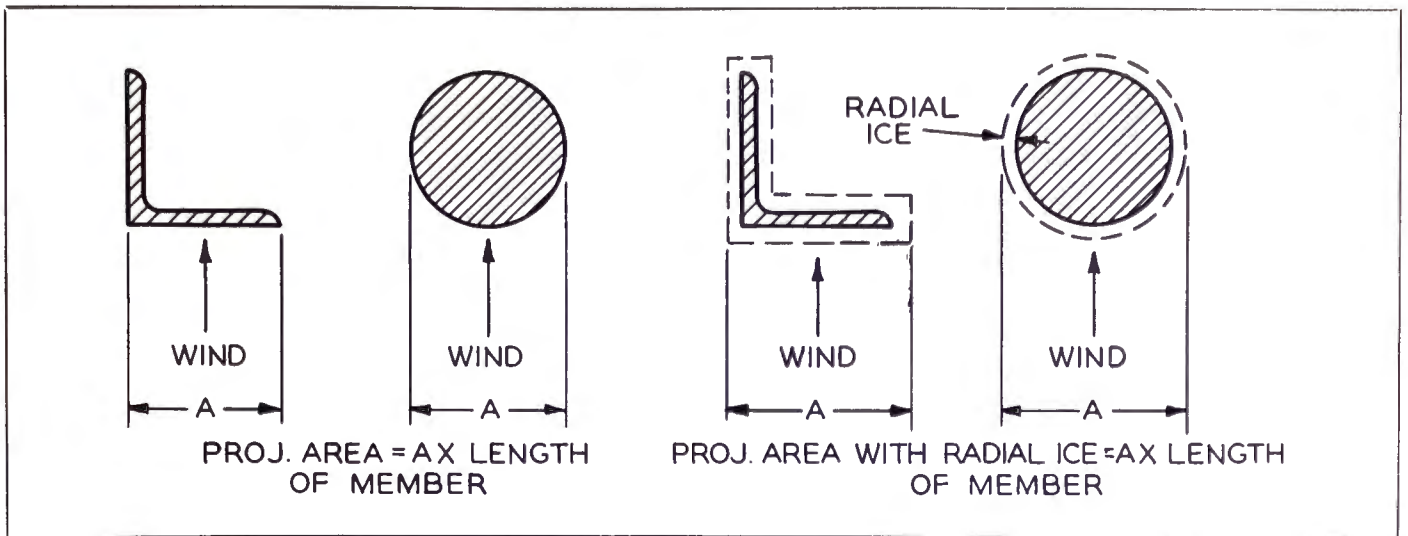

FIG. 4a. Projected area of tower members.

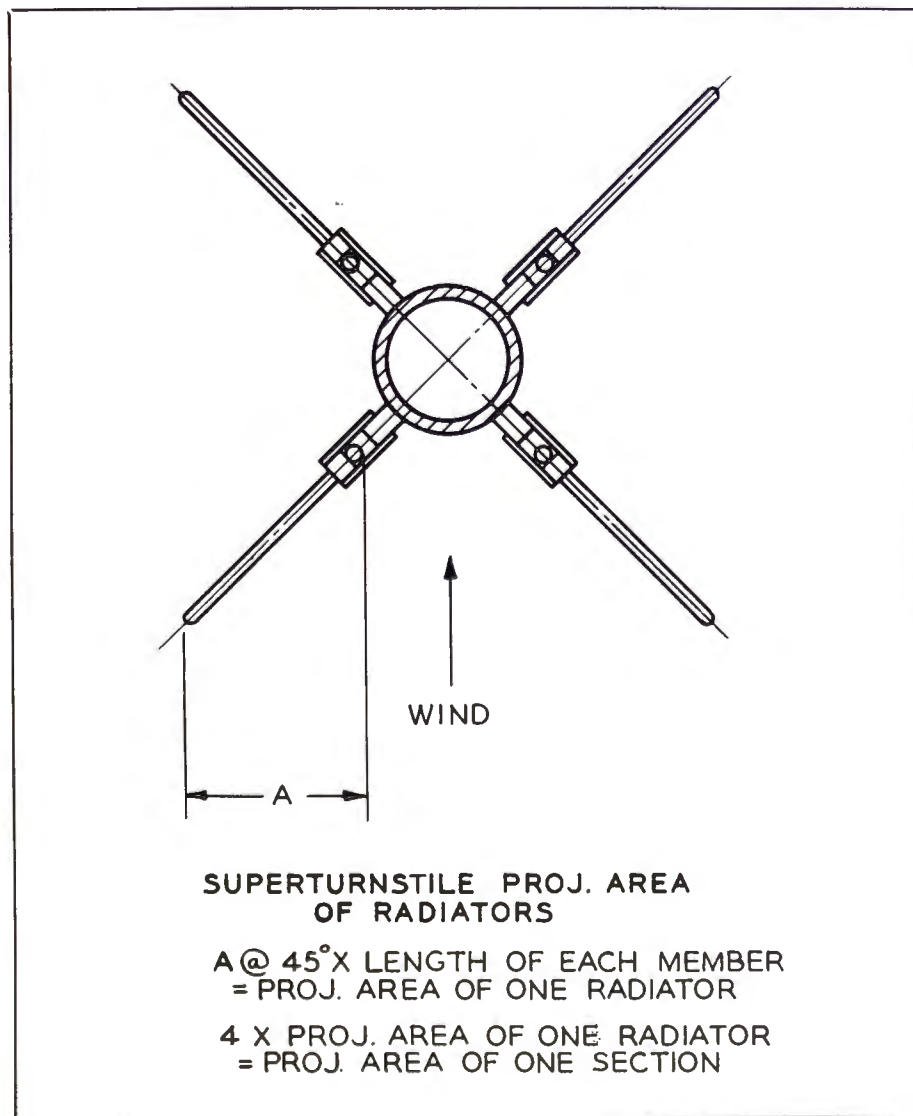

FIG. 4b. Projected area of Superturnstile radiators.

is increased by approximately 50% with $\frac{1}{2}$ inch ice, 75% with 1 inch ice and 140% with 2 inches of radial ice. Weather records should be studied to determine the probable high winds that coincide with ice coatings on the structure.

Calculated wind load is applied to towers in accordance with RETMA specifications. The wind load for triangular towers is applied to 1.5 times the projected area of one tower face plus 1.0 times the area of the ladder, transmission line and conduit. The area of one face includes all web members and two legs. The maximum web stress is obtained by applying the total wind load as determined above, parallel to one tower face and the maximum leg stress by applying the load perpendicular to one face. (Fig. 6.)

For square towers the wind load is applied to 1.75 times the projected area of one tower face plus 1.0 times the area of the ladder, transmission line and conduit. The maximum web stress is obtained by applying the total wind load parallel to one tower face and the maximum leg stress by applying the load at 45 degrees to one face. (Fig. 6.)

For guyed towers the wind on the guys is considered to be acting in the same direction as indicated above. One half the total wind load of the guys is applied to the tower and one half to the anchor. A reduced load is considered due to the angle of the guys.

The 1.5 factor for triangular towers and 1.75 for square towers is the result of wind tunnel tests taken to determine the additional area affected by the back drag of the wind.

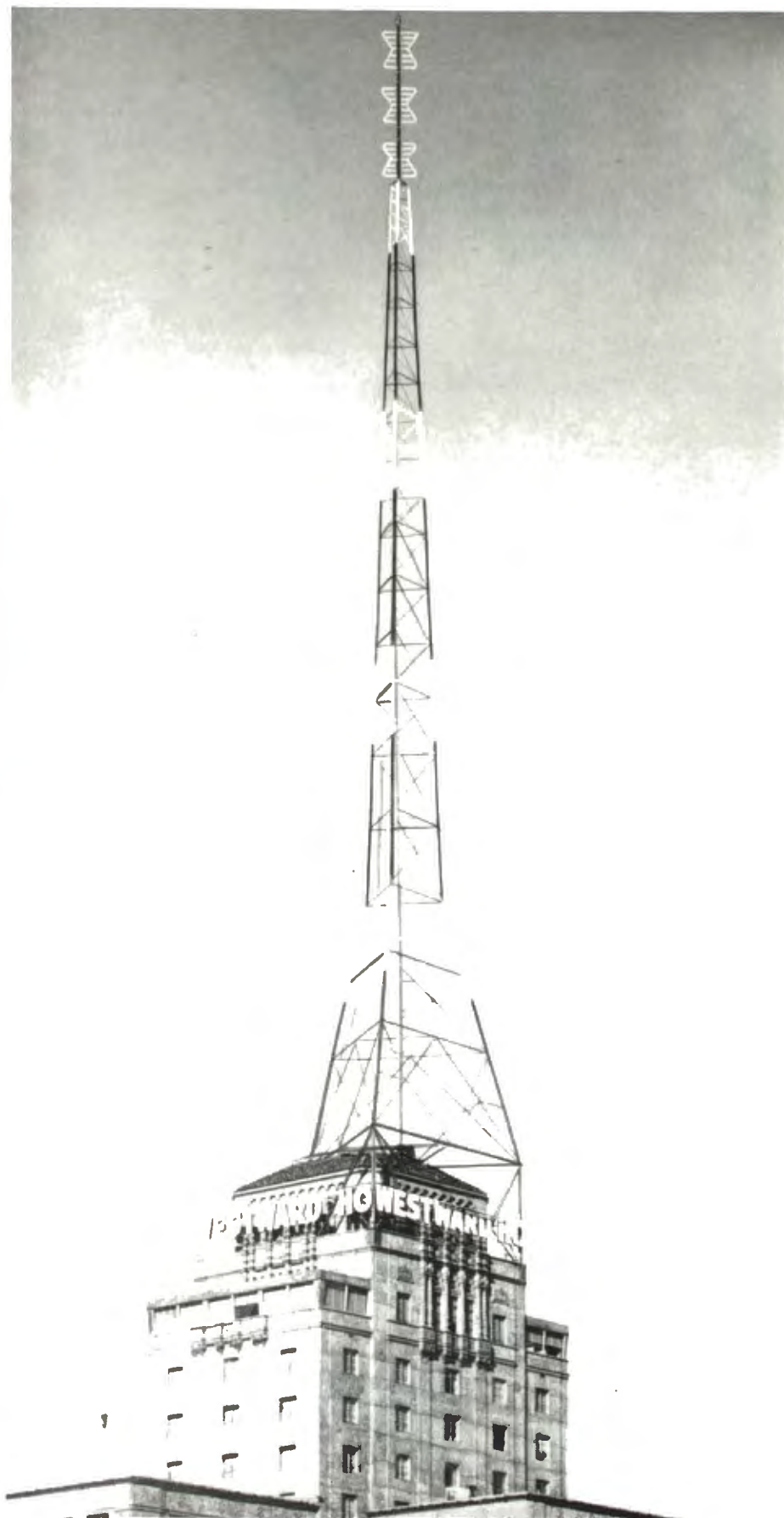

The wind load on transmitting antennas, such as TV or FM antennas which are mounted on top of towers, is determined by multiplying the design pressure (or load) by the total projected area of the antenna. This wind load, usually designated as "R" is considered to be acting at a distance above the base of the antenna corresponding to the effective center of wind pressure. This distance multiplied by the total wind load "R" gives the overturning moment of the antenna in foot pounds acting at the tower top.

In designating the rated wind load of towers and antennas, it is customary to state the wind load in terms of flat surface pressure, even though all the members may be cylindrical. The actual loading on round members is then 2/3 of that on flat members. A 60 pound loading therefore means 60 pounds per square foot on flat surfaces and 40 pounds per square foot on round surfaces.

Wind Velocity and Pressure Map

The wind pressure map shown in Fig. 7 is the result of extensive data secured from U. S. Weather Bureau records. The plotted areas shown on the map are derived from careful studies made by authorities in this field and the information is based on monthly and yearly average velocities, frequency of occurrence, probability of extremes, topographical conditions, etc. The table of suggested design loads for towers shown on the map is based on 20,000 pounds per square inch unit stress.

Although unusual storms and changes due to long-time trends may render inapplicable calculations based on existing data, it is believed that the use of the table for a particular area and height of tower will be found helpful. It should be kept in mind however, that installations on mountain tops, and areas subject to heavy icing conditions should be given special consideration. Building codes and zoning ordinances should also be carefully investigated.

Acknowledgments

U. S. Weather Bureau (Philadelphia Office)

H. P. Adams, Meteorologist in charge, for reviewing the text and submitting extensive data.

Edwards & Hjorth, Structural Consultants (New York) W. B. Scofield, Chief Engineer, for reviewing the text.

Dresser Ideco Co. (Columbus, Ohio) J. Roger Hayden and Associates for helpful design information.

FIG. 5. Self-supporting structure, 30# wind load, mounted on building top . . . KPHO-TV, Phoenix, Arizona.

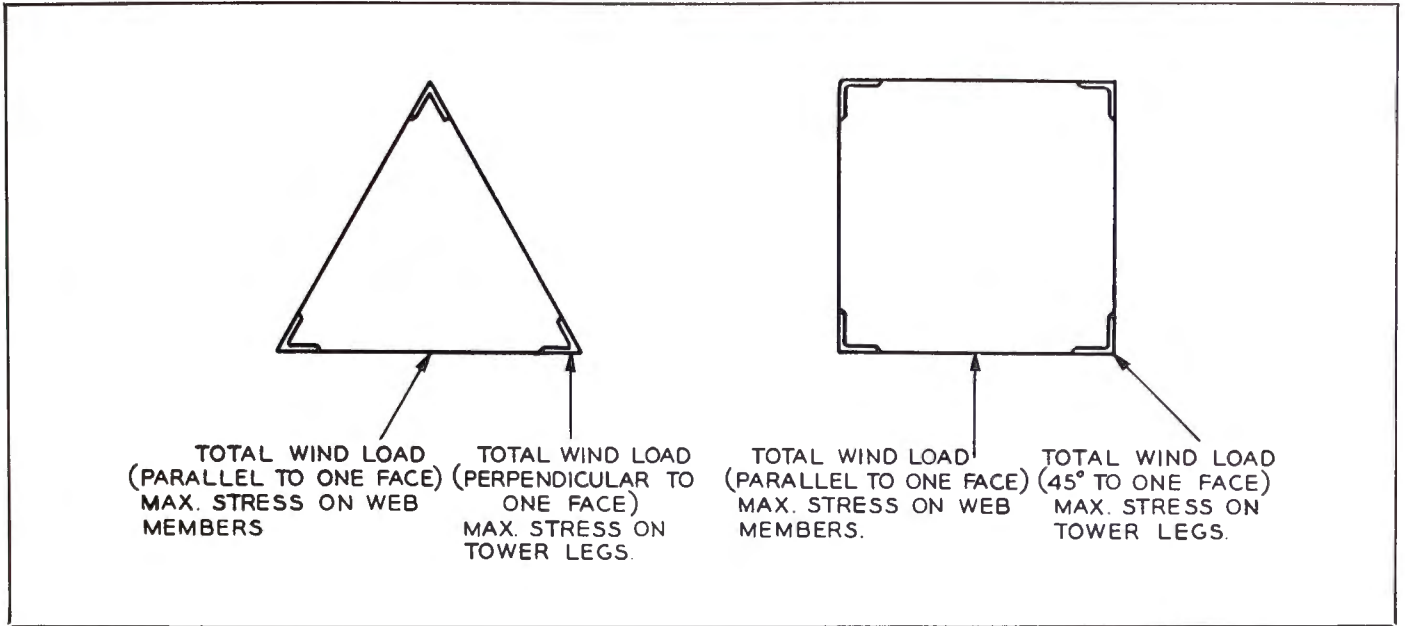
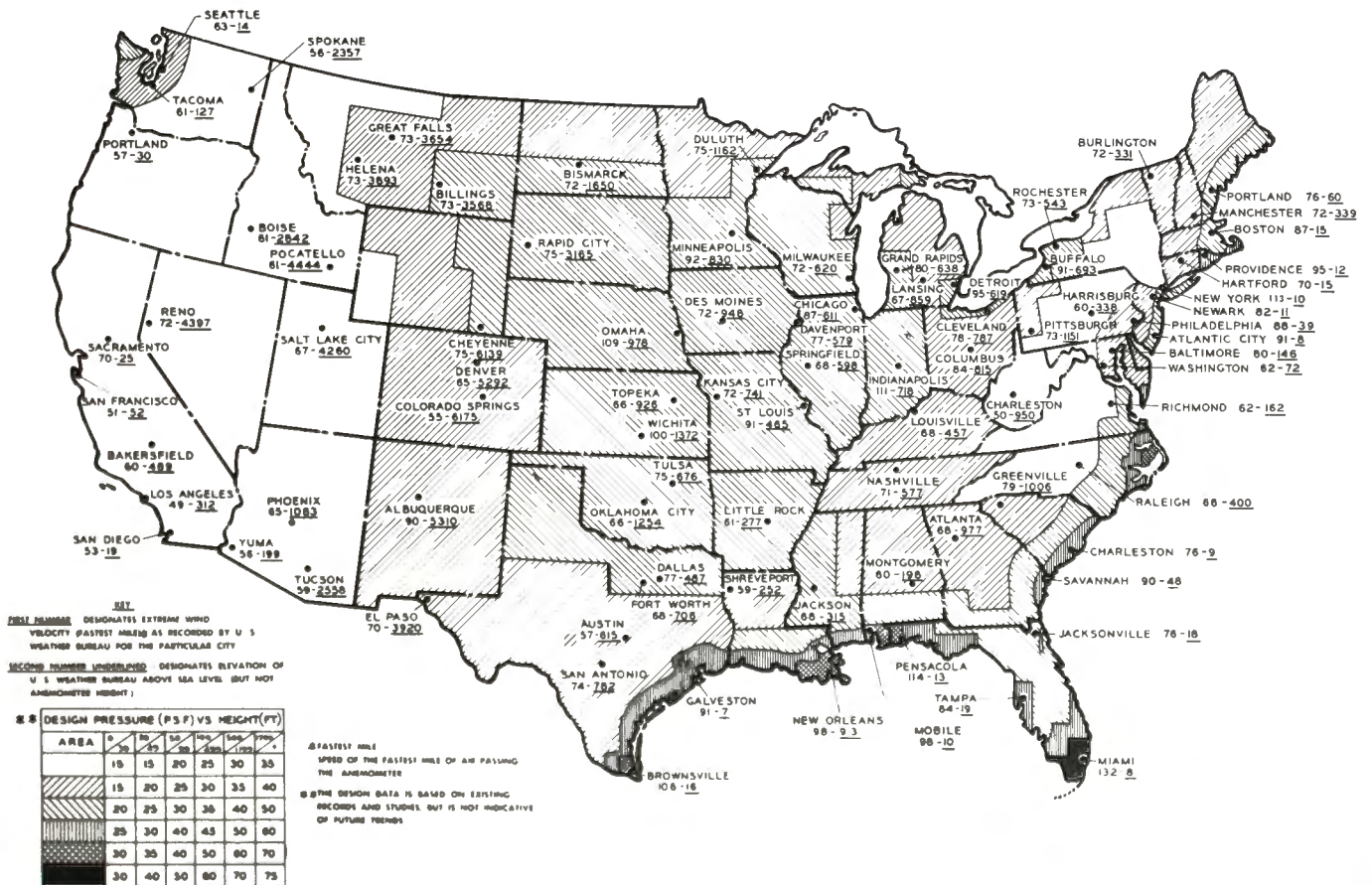

FIG. 6. Tower member Webb stress.

FIG. 7. Published records of the U. S. Weather Bureau are given as "maximum" (5 minute average velocity) or "extreme" (the speed of the fastest mile of air passing the anemometer). The selection of design loads should be based on "extreme" velocity. If no data is available on "extreme", the published "maximum" figures should be increased by approximately 20%. The plotted areas shown on the map are derived from careful studies made by authorities in this field and the information is based on monthly and yearly average velocities, frequency of occurrence, probability of extremes, topographical conditions, etc. Installations on mountain tops and areas subject to heavy icing conditions should be given special consideration. Building codes and zoning ordinances should also be carefully investigated.





TK-41 Studio Color Camera

FIG. 1. New RCA color equipment is less expensive, requires much less space, and is easy to install.



Processing Amplifier for Color Studio and Film Cameras

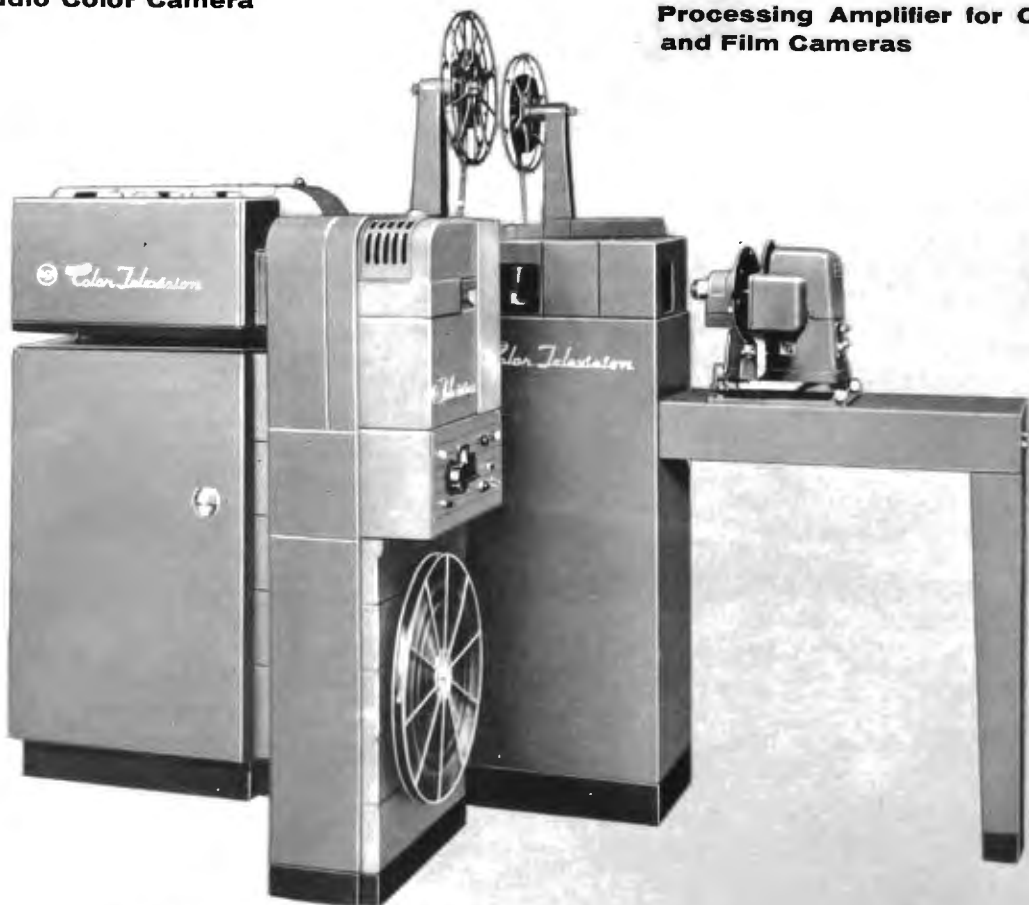

TK-26A Color Film and Slide Camera

COLOR EQUIPMENT PLANNING

Availability of 3-V Film Camera and New Studio Camera Simplifies Color Equipment Problems — New Plans Described Here Provide for Color Installation in Three Easy Steps

by

L. E. ANDERSON, Supervisor
 Studio Systems Engineering
 Engineering Products Division

Color equipment is fairly complex and relatively expensive. It, therefore, behooves the station engineer to make his color equipment plans very carefully so that he will have everything necessary to obtain high-quality color pictures, and yet avoid unnecessary duplication of expensive equipment items. Such caution is needed whether the station is just starting in color, or already has some color equipment and is now planning additions.

The single most important factor in color planning is to make sure that the individual equipment units fit together properly into a "system". Although RCA color equipment units have been designed to provide for considerable flexibility in arrangement it is, nevertheless, preferable to use them in "equipment groups" which have been carefully worked out and tested in the laboratory.

In the "color issue" of BROADCAST NEWS (Jan.-Feb. 1954), which was published

soon after the FCC authorized compatible color, lists of "equipment groupings" for various types of services were included as part of a color planning article. Most of the stations which have started color operation during the past year are using these "color equipment groupings".

The experience of these early color stations indicates that the groupings recommended were basically correct. However, since the first equipment lists were made up there have been a number of developments which effect individual items and thus make it desirable to revise these equipment lists and bring them up-to-date.

3-V Camera Eliminates One Step

The color equipment plans described previously envisaged the installation of color equipment in four progressive steps. These steps provided, respectively, for network, slide, film and live color programming. The slide and film "steps" projected in these early plans called for equipments of the "flying-spot" scanner type. As it turned out, these equipments were obsoleted, even before production, by the development of the RCA TK-26A ("3-V") Film and Slide Camera.

The "3-V" Camera, in addition to its quality and simplicity features, has the great advantage of being easily multiplexed. Thus a single camera, with a relatively simple optical multiplexer, may be used for slides, 16mm films, and 35mm films, interchangeably. This makes it possible to eliminate one of the "steps" in the original plan and thereby to effect a considerable saving in cost as well as in space required.

New Designs Effect Space Savings

During the past year RCA engineers, in addition to developing the 3-V camera, have redesigned many of the items in the RCA color equipment line. These new equipments simplify color installation and effect an additional, and very considerable, reduction in space required. One of the most important of these is the new Processing Amplifier which combines in a single unit the functions previously performed by four units. Additionally, this unit has been designed so that it can be mounted in a console type housing (see illustration on opposite page) which also contains the camera control panel. This not only saves rack space, but also makes operating more convenient by concentrating the controls.

Fig. 2
THREE-STEP PROGRAM FOR COLOR

<i>Step No.</i>	<i>Equipment Added</i>	<i>Program Sources Provided</i>
Step #1	Network color equipment	Provides for transmission of color programs received from network source
	Color test equipment	Needed by all stations for checking, controlling and maintaining a high quality picture
Step #2	Color bar and local origination equipment	Provides for local generation of color sync signals plus color bar signal for system checking and advance training of personnel
	Color vidicon (3-V) film and slide camera equipment	Provides for origination of color pictures from color motion picture film and color slides
Step #3	Color studio camera equipment	Provides for origination of live studio pictures in color

The new Processing Amplifier is an important part of the new RCA TK-41A Studio Camera Chain. The camera proper of the TK-41A is identical in appearance to TK-40 and only minor changes have been made internally. However, the associated auxiliary equipment has been completely redesigned around the new Processing Amplifier. In addition to improving performance this has reduced the required rack space from four racks to two.

The new Processing Amplifier is also used in the TK-26A "3-V" Film Camera Chain. This is important in standardizing the equipment in the station. Also it reduces the rack space required for film camera auxiliary equipment from three racks to two.

Another unit which has been completely redesigned is the sync generator. The new TG-2A Generator (for color and monochrome) provides improved performance and requires only one-third the space of the old Type TG-1A. Two of these new sync generators, a changeover switch, the frequency standard and the color subcarrier generator can now be housed in one rack.

The savings in rack space effected by these redesigns, plus the saving in eliminating the slide camera equipment, have reduced the equipment space needed for a complete color operation (all three steps) to approximately half that originally required. Where eleven racks previously were required for auxiliary equipment it is found that six (in some cases only five) will now suffice. This, together with the fact that only one camera-projector group is now required for film and slides (instead of two separate groups) should do much to

alleviate the space problem which confronts almost all stations.

The New 3-Step Plan for Color

The changes in required equipment occurring as a result of equipment design changes, plus minor changes indicated by field experience, have been incorporated in a new "3-step" plan for color. The steps in the new plan are:

Step 1—Installation of equipment for telecasting network programs.

Step 2—Addition of equipment for telecasting color slides and color films.

Step 3—Addition of equipment for telecasting live color studio programs.

It will be noted that these steps are clearly defined. They permit a station to start on a modest basis with *Step 1* and to take additional steps whenever desirable. They have been carefully planned so that no unnecessary duplication or extra cost will be involved in doing this.

Each step is described in detail in the following pages. Included in these descriptions are lists of equipment. It should be noted that there are five groups of equipment. Three of these groups represent the particular equipment needed for each type of programming. The other two groups are the color bar and local color origination equipment group and the color test equipment group. The table (Fig. 2) indicates the equipment groups ordinarily needed for each step. However, in some cases the Color Test Equipment or the Color Bar and Local Origination Equipment may be ordered separately, or in different steps. They are, therefore, listed separately here, as well as in RCA equipment proposals.

WP-33B POWER SUPPLY (MONO CAM NO 1)	WP-33B POWER SUPPLY (MONO CAM NO 2)	TA-1A DIST AMP	BLANK TA-3A D A NO 2 TA-3A D A NO 3 TA-3A D A NO 4
WP-33B POWER SUPPLY (MONO CAM NO 1)	WP-33B POWER SUPPLY (MONO CAM NO 2)	TG-2A SYNC. GENERATOR	TA-5D NO 1 STAB AMP (NET)
580-D POWER SUPPLY (MONO CAM NO 1)	580-D POWER SUPPLY (MONO CAM NO 2)	BLANK	BLANK VIDEO JACK PANEL VIDEO JACK PANEL BLANK
CURRENT REGULATOR (MONO CAM NO 1)	CURRENT REGULATOR (MONO CAM NO 2)	580-D POWER SUPPLY (STAB AMP NO 1) NET	TA-5D NO 2 STAB AMP (LINE)
WP-33B POWER SUPPLY (FILM CAMERA MONO)	WP-33B POWER SUPPLY (TA-3A'S)	580-D POWER SUPPLY (STAB AMP NO 2) LINE	FILM CAMERA CONTROL CHASSIS
WP-33B POWER SUPPLY (FILM CAMERA MONO)	WP-33B POWER SUPPLY (PV MON)	580-D POWER SUPPLY (TA-1A)	FILM CAMERA DEFLECTION CHASSIS

FIG. 3. Arrangement of the rack-mounted units of a typical monochrome station of the type indicated in the block diagram of Fig. 4. On following pages are similar rack diagrams showing how the rack-mounted color equipment units of each step may be added to the rack assembly shown here. It should be noted that these rack layouts are intended to indicate the general approach only. Details will vary according to individual station requirements.

Integration With Monochrome

It is felt that most stations will wish to keep their color programming facilities more or less separate from their monochrome facilities (at least during the transition period). However, smooth station operation will require some provision for switching between the two facilities. This means that parts, at least, of the switching

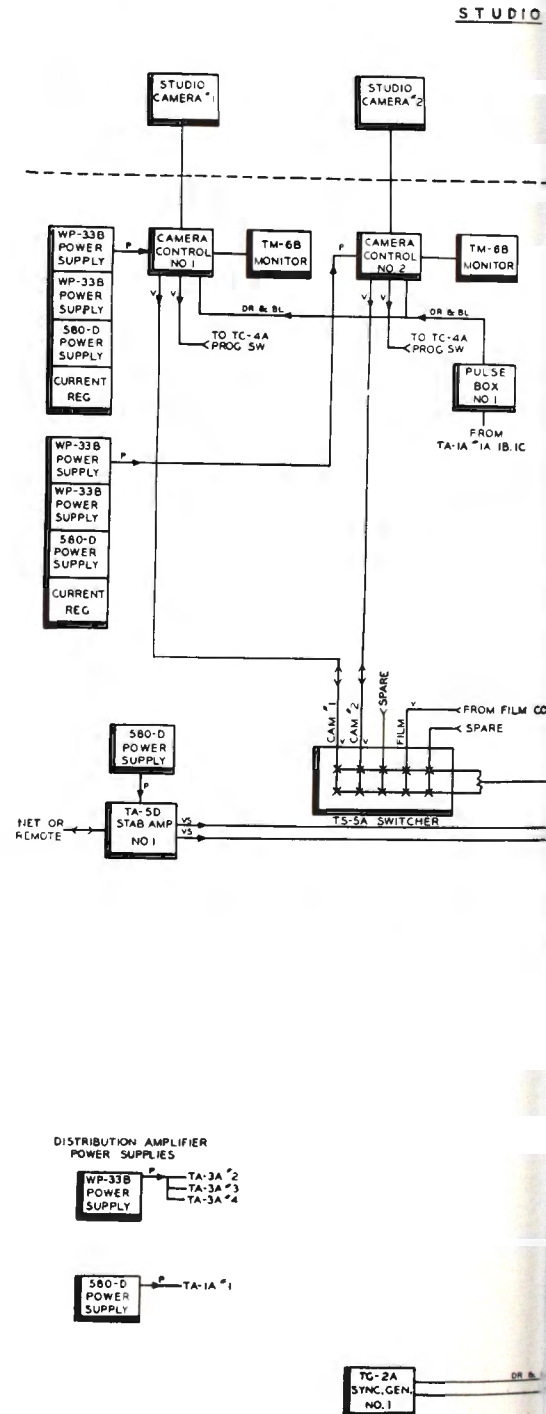

system, and some items associated with it (such as stabilizing amplifiers, distribution amplifiers, etc.) will have to function for both monochrome and color. Other items, such as sync generator, should preferably be able to function in emergency for either color or monochrome. If a microwave link to the transmitter is used it must, of course, be good for either service.

To provide these "cross-overs" requires a certain amount of integration. To show how this can be worked out the color equipment steps described in the following pages have been related to a typical monochrome equipment setup such as might be found in an existing station. As each succeeding color equipment group is added a functional diagram is shown which includes not

only the color equipment (at that stage) but also the original monochrome equipment. A simplified diagram of the monochrome setup which serves as a starting point is shown in Fig. 3. While existing stations will differ from this in some degree it is felt that the general arrangement is sufficiently typical to illustrate the basic considerations.

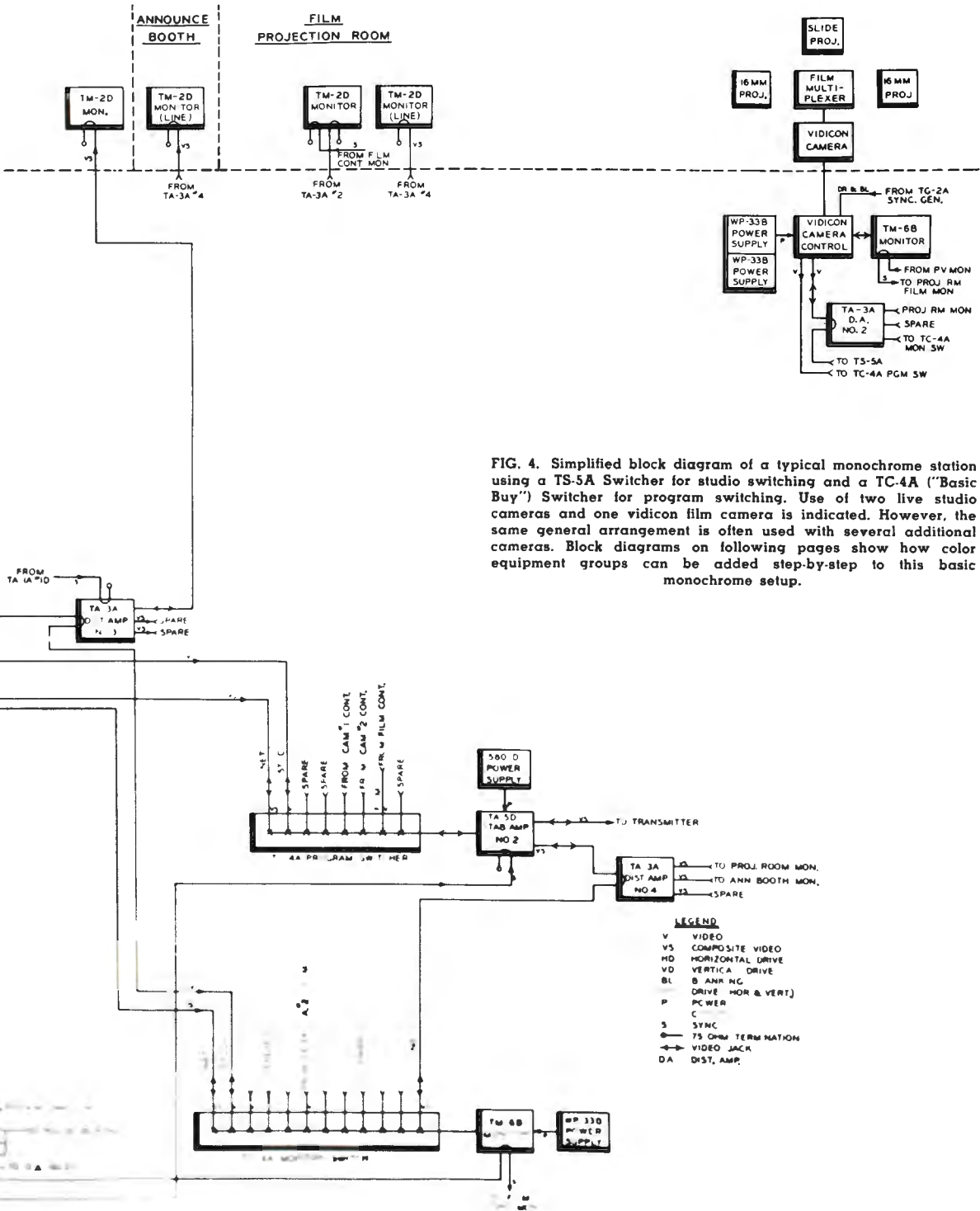

FIG. 4. Simplified block diagram of a typical monochrome station using a TS-5A Switcher for studio switching and a TC-4A ("Basic Buy") Switcher for program switching. Use of two live studio cameras and one vidicon film camera is indicated. However, the same general arrangement is often used with several additional cameras. Block diagrams on following pages show how color equipment groups can be added step-by-step to this basic monochrome setup.

STEP 1 - Installation of Equipment for Telecasting of Network Color Programs (No Local Origination)

Many television stations have made a start in color programming by installing just the equipment needed for telecasting color programs received from the network. The amount of equipment required is relatively small and consists of units all stations will require, regardless of whether they start with just this step or simultaneously install more elaborate color programming facilities.

A list of major equipment items for *Step 1* is shown in the box below. This consists of two equipment groups. The first includes all video equipment (amplifiers, phase-correcting networks and monitors) needed to transmit color. The second includes the test equipment items necessary to be certain of high-quality operation.

Equipment Modifications at Studio

The equipment listed in *Step 1* assumes that no additional equipment will be needed at the studio. If the existing mono-

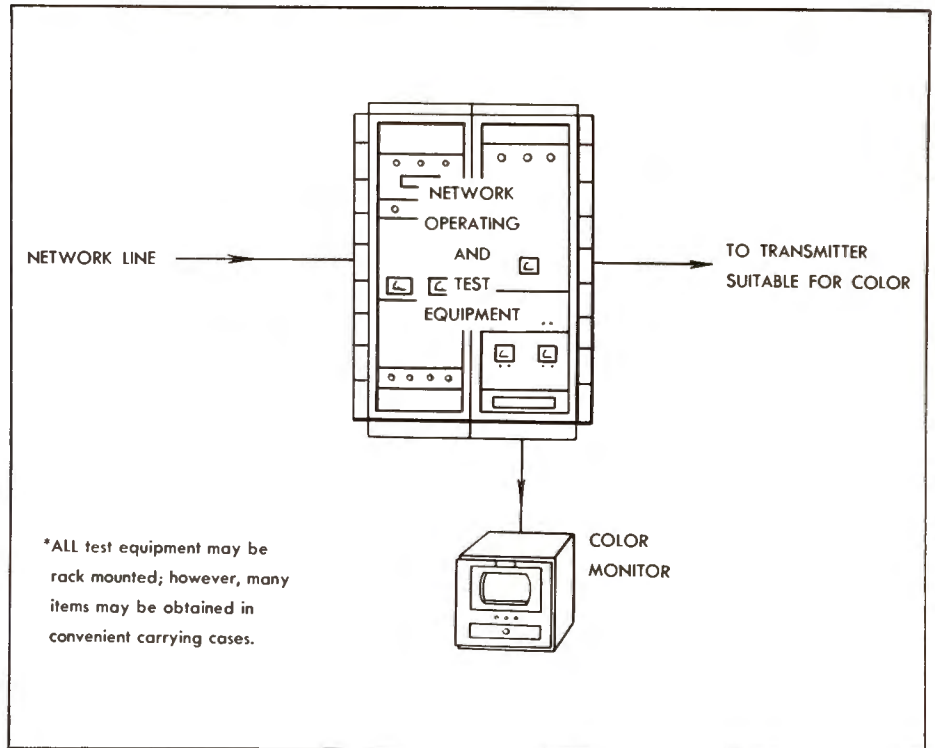

FIG. 5. The major equipment items added in Step 1 include rack-mounted video and test equipment, and a color monitor which may be either rack or cabinet mounted. Ordinarily this equipment will be located in the transmitter control room. Use of two racks is indicated but in many instances one rack will provide sufficient space to house all the equipment.

Step #1 Equipment

COLOR NETWORK OPERATING EQUIPMENT

Qty.	Description
1	Type TA-7B, Color Stabilizing Amplifier
1	580-D Power Supply
1	Type TM-10B Color Monitor
1	Set of Phase Correction Equalizers
1	Color Correction Kit for Demodulator
3	TA-3A Distribution Amplifiers
1	WP-33-B Power Supply
2	Type BR-84 Cabinet Racks
1	Type WA-8A, Color Stripe Generator

COLOR TEST EQUIPMENT FOR NETWORK OPERATION

1	Type WA-7B Linearity Checker
1	Type WA-6B Color Signal Analyzer
1	Type WA-4A Burst Controlled Oscillator
1	Type WR-61A Service Color Bar Generator (for adjusting monitors and receivers)
1	WA-9A Calibration Pulse Generator
1	Type TO-524-D Television Oscilloscope
1	Type 500 Scopemobile for MI-26500
1	*Type WA-3B Grating and Dot Generator

* Grating and dot patterns are included as output signals of the TG-2A Sync Generator. Therefore, the WA-3B is not needed unless a separate source of signal may be desired.

chrome equipment is arranged as shown in Fig. 4 (preceding page) it can be used for color with very minor modifications. These would consist of minor changes in the two stabilizing amplifiers (color modification kits are available for the RCA TA-5B, TA-5C and TA-5D) plus checking, and possibly minor changes in, interconnecting lines. The Type TC-4A Switcher shown is satisfactory for color switching, as are RCA Types TS-5A, TS-10A, TS-11A and TS-20A (also the MI-26277 Monitoring Switch). If other types are used they will require checking and possible modification.

Video Equipment at Transmitter

A complete set of video input equipment for the transmitter location is included in *Step 1*. The suggested arrangement of this equipment is shown in Fig. 6. The composite color signal from the studio (or directly from the net) is fed first to a Type TA-3A Distribution Amplifier. This distribution amplifier, which was particularly designed for color systems, provides sending end termination, variable gain from 0 to 2, and a sync addition circuit. (The

older TA-1A Distribution Amplifier can be used for color if two sections are paralleled to provide necessary sending end termination).

From the distribution amplifier the color signal is fed to a Type TA-7B Color Stabilizing Amplifier. This amplifier differs from the monochrome models (5B, C, D) in that it is designed to pass the color sub-carrier "burst" and in addition incorporates a non-linear amplifier. Its use at this point in the system is necessary in order to provide setup and white stretch adjustments for proper operation of the transmitter.

Phase Correction Equalizers

In order to comply with the FCC standards, two phase correction equalizers must be installed in the input line to the transmitter as shown in Fig. 6. These provide a calculated amount of phase predistortion to make up for phase distortion in the rest of the system. The low-frequency network compensates for the phase shift in the vestigial side-band filter. The high-frequency network compensates for the defi-

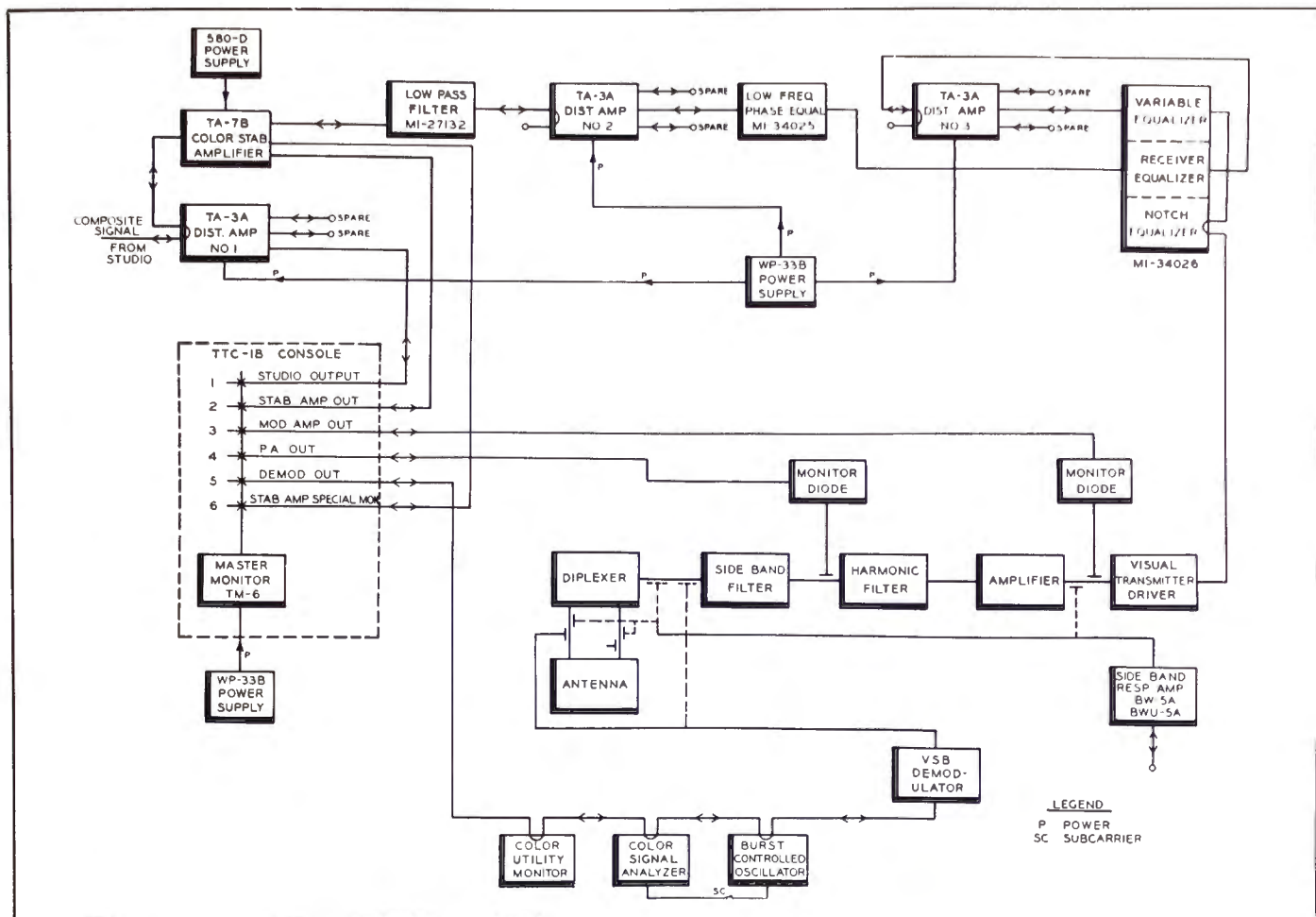

FIG. 6. Simplified block diagram showing how Step 1 color equipment can be integrated with existing monochrome equipment at the transmitter location. The several components of the transmitter and antenna systems are indicated as separate blocks in order to show the arrangement of switching and monitoring circuits which are needed for good color operation.

ciency in high-frequency response of the receiver. This equipment is rack mounted external to the transmitter with other items such as the color stabilizing amplifier and distribution amplifiers.

Monitoring Equipment

In order to be able to visually monitor the picture transmitter, a Type TM-10B color monitor is required. The color monitor must be fed from a high-quality demodulator. Most stations presently have either a BW-4A or BWU-4A Demodulator. With minor modifications either of these may be used. A demodulator conversion kit is supplied as part of Step 1 equipment for making the necessary changes. A standard monochrome monitor is used (in addition to the tri-color monitor); however, this unit is not listed in the "required equipment" since the monitor which is part of the standard transmitter control console can be used for this purpose.

Color Stripe Generator

In areas where color programs are tele-

cast only occasionally it is difficult for servicemen to check color receiver installations. Most servicemen have a portable bar and dot generator with which they can check the operation of the color receiver itself. However, if there is no color signal on the air they are unable to check the antenna and transmission line. In color transmission it has been found that in some cases multi-path effects have a tendency to cancel the color burst. Faulty transmission lines also sometimes result in loss of color. For this reason the serviceman should make an "on-air" check of every color installation.

Stations can help the serviceman by using a WA-8A Color Stripe Generator. This unit, when inserted in the video line feeding the transmitter, generates two color bursts, one at the beginning and one at the end of each horizontal scanning line. This produces a vertical yellow-green stripe at the right-hand edge of the monochrome picture. The stripe is imperceptible on a monochrome receiver but is easily observed

on color sets by adjusting the horizontal frequency control until the color circuits of the receiver are actuated by the burst at the beginning of each line.

By using the WA-8A stations can transmit color information all day long without interfering with regular commercial monochrome operations. This enables the serviceman to determine that the transmission path is passing the color burst and that the overall installation is satisfactory.

Equipment Cabinet Racks

Two 84-inch cabinet racks are included in the Step 1 equipment list (box on opposite page). In most cases the equipment units added in Step 1 will all be located at the transmitter. If there is some existing rack space available probably only one additional rack will be needed for the color equipment. The second rack may be deleted or it may be installed at the studio for color test equipment or color video distribution units which will be added as the color operation grows.

Color Test Equipment for Step 1

High-quality color telecasting requires close adherence to carefully specified transmission standards. This can be accomplished only with an adequate amount of test equipment of the proper type. Because the color system is much more complex than monochrome a relatively large amount of test equipment is needed. Much of it is of new and unique design.

Test equipment is used in a color station for three important purposes. These are: (a) adjusting color origination equipment, such as studio and film cameras, colorplexers, etc.; (b) checking "system" elements such as distribution amplifiers, stabilizing amplifiers, switching equipment, S-T-L's and the main transmitter; (c) adjusting color monitoring equipment.

The first operation does not occur in a Step 1 color station since no "origination" equipment is involved. (Thus the WA-1D Color Bar Generator, which is the key unit for this purpose, is not included in required equipment until Step 2.)

A Step 1 station will have to check all system units and adjust its color monitors for proper operation. To do this, it will require nearly as many different test equipment units as a larger installation. For this reason it is strongly recommended that every station purchase a fairly complete set of test equipment as a part of its first step in color. The recommended units are listed in the box on Pg. 32, and are described below.

How It Is Used

Fig. 7 shows in chart form the test equipment setups necessary to make all basic color equipment measurements. The list of equipment included in Step 1 includes only the items necessary to make the tests shown in the top four boxes. The lower two boxes are included to show how the same units are used later (with the addition of a color bar generator) to make adjustments on local origination equipment.

Before attempting to put color pictures on the air every piece of equipment in the station system should be checked to be sure the transmission characteristics are satisfactory. Each piece of equipment through which the signal must pass introduces some distortion. Even though this distortion may be very small, it is still there and the cumulative effects of many units in series may well prevent the proper transmission of color video. Four param-

eters must be contained well within reasonable limits. These parameters are amplitude vs. frequency, phase vs frequency, differential gain, and differential phase. Differential gain is defined as the change in gain measured against the increase in signal amplitude. Differential phase is defined as the change in phase shift measured against signal amplitude.

Four instruments are provided for the precise measurement of these parameters. They are the linearity checker, the color signal analyzer, the burst controlled oscillator and the television oscilloscope.

WA-7B Linearity Checker

The differential gain characteristics of any unit of the system, or the system itself, can be measured with the WA-7B Linearity Checker and the TO-524-D Oscilloscope. The linearity checker has an output signal consisting of a low-frequency step wave with an RF signal superimposed on it. This signal is fed into the system under test and the output is observed on the 524-D oscilloscope after being passed through a high-low filter which is a part of the WA-7B. When the filter switch is in the high position the step wave is removed from the output signal and only the RF components remain. Any change in amplitude of the RF envelope from beginning to end of sweep indicates differential gain distortion and the percent change in amplitude of the RF pattern is the measure of differential gain distortion in the system.

WA-6A Color Signal Analyzer

The WA-6A Color Signal Analyzer is used with the linearity checker and scope (as shown in second box, Fig. 7) to measure the subcarrier phase shift and the differential phase of the system. Two input signals are required for operation of the Color Signal Analyzer: (1) the composite color signal to be measured and (2) a continuous reference subcarrier signal. For making phase measurements, both these signals are provided by the Linearity Checker. In Steps 2 and 3 the Color Signal Analyzer is used (in conjunction with the WA-1D Color Bar Generator) for precise alignment of the colorplexers (as shown in fifth box, Fig. 7).

WA-4A Burst Controlled Oscillator

In many instances a source of subcarrier for use with the signal analyzer may not be available such as at a transmitter loca-

tion remote from the studio facilities. To measure the four parameters involved in color transmission of a studio transmitter link, it would be necessary to have available a source of subcarrier. The WA-4A Burst Controlled Oscillator fulfills this requirement. The color burst is picked off the incoming signal and used to precisely control a crystal oscillator, the output of which is a continuous subcarrier signal. This item is not needed if the studio and transmitter are at the same location and if test measurements are not required at a point remote from the location of the Linearity Checker.

WA-3B Grating and Dot Generator

The WA-3B Grating and Dot Generator is used (as shown in box four, Fig. 7) to adjust the deflection linearity of any monitor by means of the grating pattern signal output. This signal produces a grid pattern on the monitor consisting of horizontal and vertical lines. Any difference in the spacing of the lines over the face of the monitor represents non-linear deflection.

The dot output of the WA-3B is used for checking the beam convergence adjustment of color monitors. The dots are really rectangles about 9 lines in each dimension, but adjustable in size to suit the individual using the instrument. If the convergence is not set properly, dots of three different colors appear displaced from one another by the divergence of the respective beams. If properly adjusted, only white dots appear on the monitor with a minimum of color fringing.

Grating and dot patterns similar to those generated by the WA-3B are included as output signals of the TG-2A Sync Generator. Therefore, the WA-3B is not needed with the TG-2A unless a separate source of signals is desired.

WA-9A Calibration Pulse Generator

This unit, although not used in the tests shown in Fig. 7, is strongly recommended as a part of every color station's test equipment. Designed for the accurate calibration of studio signal voltages it can be installed in a television system as one input to a switcher or it may be made available at a jack panel so that it can be patched to any part of the system as desired.

For permanent installation, it is convenient to have the WA-9A installed in master control and on one cable fed to all

FIG. 7. Chart showing how various units of color test equipment (solid black blocks) are used to test the several parameters of the system. The tests indicated in the top four boxes are required in all steps and can be made with the test equipment units listed in the box on page 32. The tests indicated in the lower two boxes are required in Steps 2 and 3. For these a color bar generator is required in addition to the original list of test equipment.

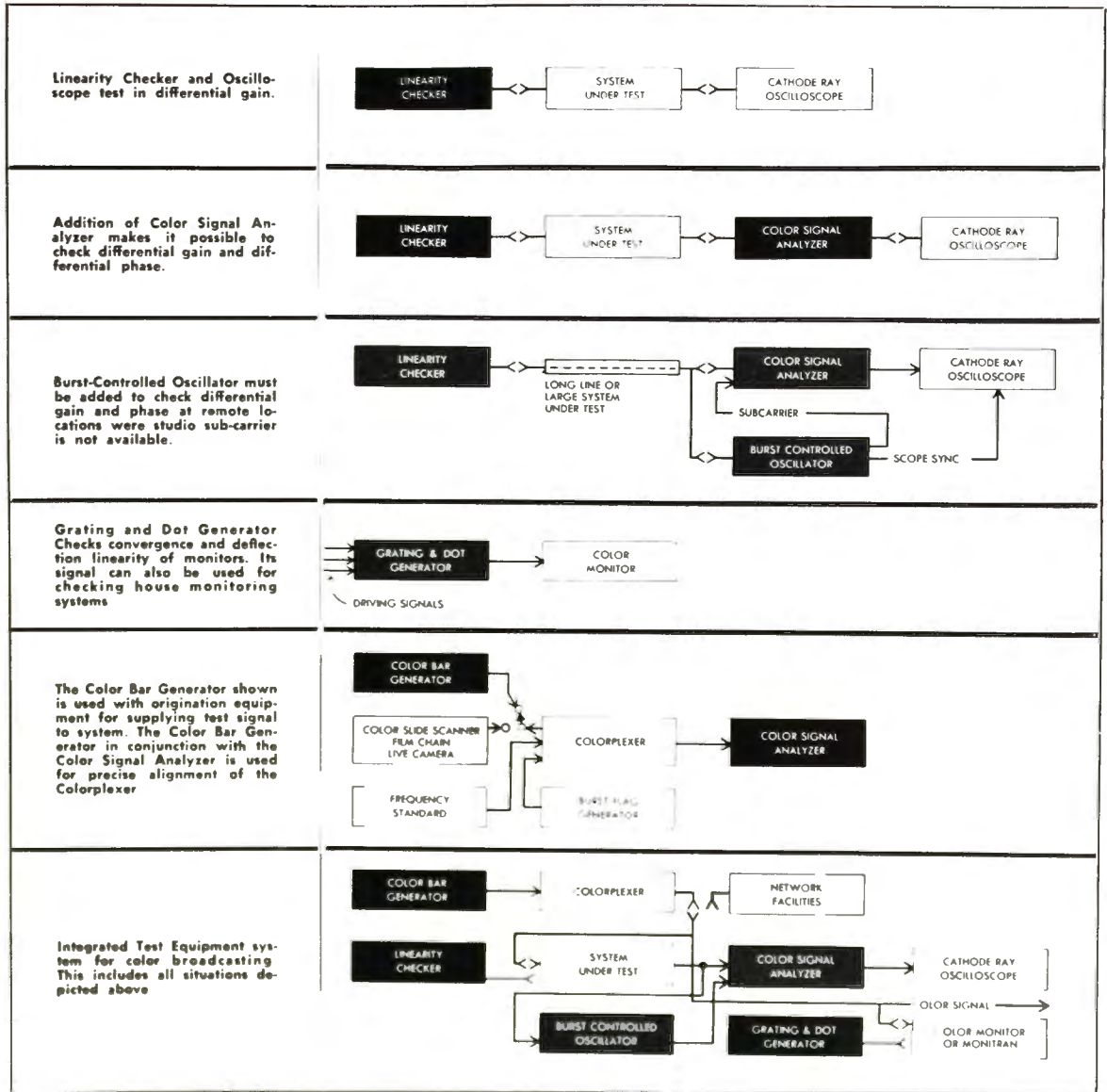

studios or other sources of signal so that operating personnel can have it available at any time. It can also be used to calibrate all master monitors and oscilloscopes by merely substituting it for the normal input signal. When it is used as a video input to a switcher, it can be rapidly switched in and out for precise matching of video signals from various sources.

The WA-9A is also very useful in setting up the processing amplifier in the 3-V color film chain. Here the WA-9A makes possible an accurate match between all three color channels. Switches are provided on the processing amplifiers for rapidly switching between the signal voltages and the calibration pulse signal.

TO-524-D Oscilloscope

The 524-D oscilloscope is an instrument designed especially for television applications. The wide bandwidth coupled with the precisely controlled sweep circuits provide for observing almost every conceivable point of interest in a composite signal. The trigger circuits make it possible to examine very minutely the vertical synchronizing interval as well as each horizontal line. This is useful when determining the position of the burst with respect to horizontal sync and blanking signals.

WA-2B Video Sweep Generator

This unit is not included in the Step 1 list of equipment because most stations already have one. The WA-2B is a very

versatile instrument which has a sweep output from 100 kc to 10 mc. It is used for determining amplitude frequency characteristics of the system.

WR-61A Service Color Bar Generator

This unit, which should not be confused with the WA-1D Color Bar Generator furnished in Step 2, is a portable, service-type instrument designed to be used by servicemen in adjusting color receiver in home installation. It produces on the color receiver screen a series of vertical color bars (60 in number) and evenly spaced over the screen. It cannot be used for generating color signal. However, it is very useful in Step 1 for making up test equipment for monitors and receivers.

STEP 2-Addition of Equipment For Telecasting Color Slides and Color Films from Your Own Studios

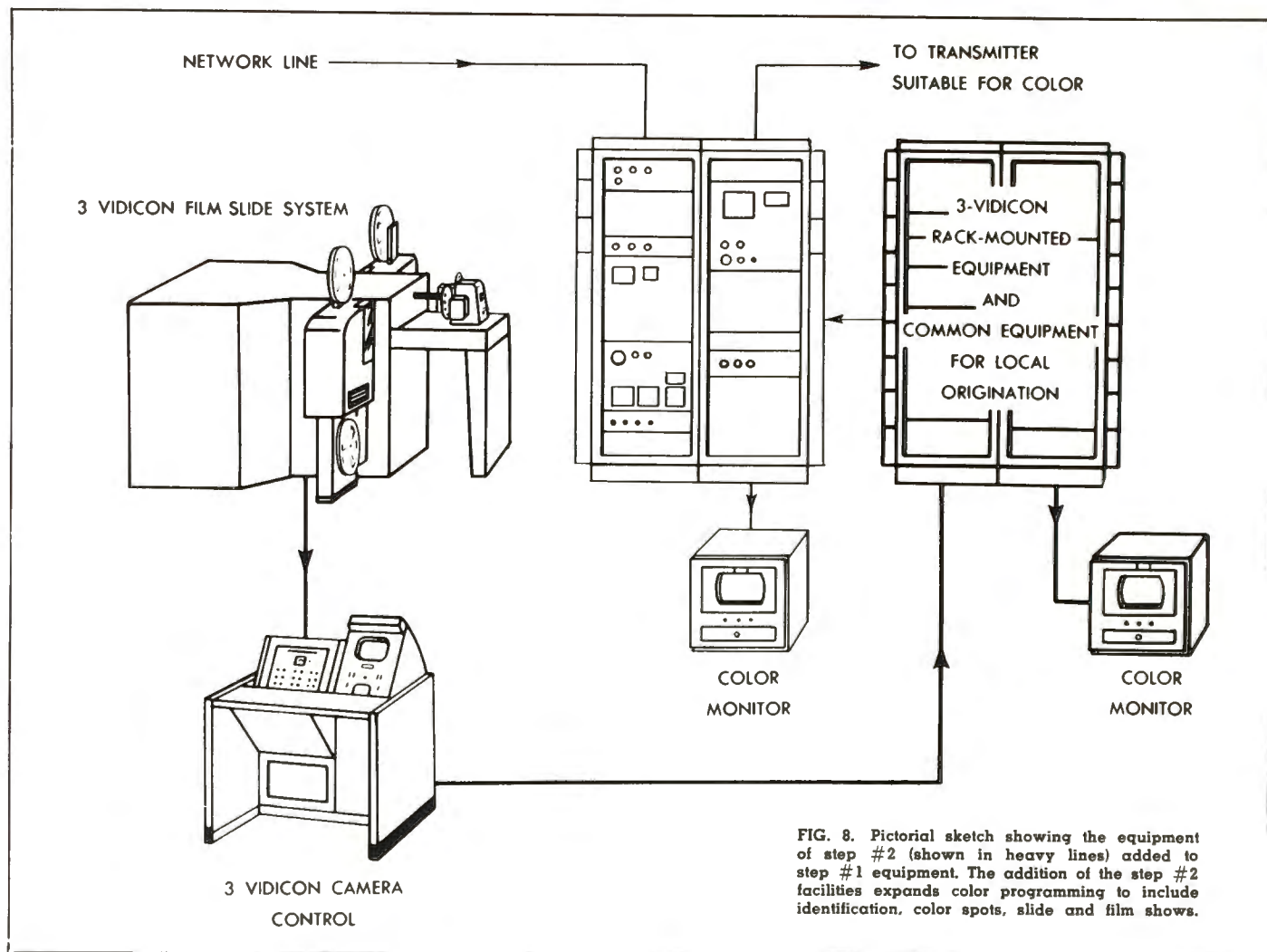

FIG. 8. Pictorial sketch showing the equipment of step #2 (shown in heavy lines) added to step #1 equipment. The addition of the step #2 facilities expands color programming to include identification, color spots, slide and film shows.

For most stations the second step in color will be the addition of equipment for telecasting color slides and color film.

Color films provide the simplest means of originating color programs at the local level. It is expected that before long many of the syndicated film programs will be made available in color. Color films are also of great interest to the advertiser. One of the big attractions of color is the much greater interest it will lend to product advertising. At the present time many "commercials" are supplied on short film strips. With the growth of color this trend will undoubtedly increase. In addition, there are many short subjects that are available in 16mm color film which program departments will be anxious to use.

Availability of equipment for telecasting their own color slides will enable stations to make station breaks in color (definitely desirable when telecasting network programs in color) and to sell color "spots" to local and national advertisers. Color slide programs are relatively easy to make up because 35mm color transparencies can be used as color slides.

Equipment Required

The equipment for televising color slides and films does not require a large amount of additional space and operating cost is reasonable. Thus it represents a much smaller and less expensive step than installation of live studio color. The arrangement of such equipment is indicated pictorially in Fig. 8. A list of the equipment

items which must be added (in order to make a *Step 1* station into a *Step 2* station) is shown in the box on the opposite page.

It will be noted that this equipment is divided into two groupings. The first group, referred to as "Color Bar and Local Origination Equipment", includes the units necessary to generate color sync signals locally plus a studio-type color bar generator and a colorplexer. The second group includes the film/slide camera chain plus associated projectors, multiplexer, etc.

A station which telecasts only network color (*Step 1*) does not require a local sync generator because the color signal received over the network line is a complete

composite signal (i.e., it includes all necessary sync pulses as well as picture signals). However, when a station decides to start local color programming, (no matter how simple) the color sync signals, as well as the color picture signals, must be generated locally. Thus before a station can start color slide programming it must install its own color sync generating equipment.

The color bar generator is required in order to correctly adjust the colorplexer used with film and studio cameras. Thus it is a necessary prerequisite to *Step 2* operation. It also provides a convenient means of generating a color test signal which is very useful in testing and measuring of studio and transmitter systems. In addition the color bar signal can be used as an on-the-air signal during periods when regular commercial transmission is not in progress so that servicemen may utilize this signal for the adjustment of color receivers.

In order to familiarize and train station personnel in advance with color TV equipment and principles, some stations may wish to install the color bar generator and local origination equipment well ahead of the film and slide camera facilities. In order to show how this may be done the following description of the *Step 2* equipment has been divided into two parts. Part I covers

installation of the Color Bar and Local Origination Equipment only. Part II describes installation of the film and slide camera chain, projectors and associated equipment.

STEP 2 — PART I

Color Bar and Local Origination Equipment

The list of equipment units included in this grouping is shown in the box below. The functional arrangement of these units (when added to the station described in Step 1) is shown in Fig. 12. All of these equipments have been described in detail elsewhere. However, a short description is included here in order that overall operation may be better understood.

Color Sync Signal Requirements

Color sync signals differ from monochrome sync signals in two major respects. One is that they have a "burst" of subcarrier frequency (3.6 mc) superimposed on the "back porch" of the horizontal sync pulse. This "burst" is supplied by a Burst Flag Generator.

The second difference in color sync signals is that they are controlled by the subcarrier oscillator (rather than the 60-cycle supply). This thermostatically controlled 3.6 mc oscillator is contained in the Color Frequency Standard.

Although these units could be used with the sync generator originally installed for monochrome transmission this is not recommended because changing from monochrome to color, or vice versa, would cause a break in the sync signals fed the receiver. For this reason a new TG-2A Sync Generator has been included in the list.

Color Frequency Standard (MI-40201)

This unit provides the color synchronizing information necessary for proper color operation. The subcarrier output of the frequency standard is fed to each colorplexer where it is modulated with the chroma information. Another output from the frequency standard is used to synchronize the sync generator to the frequency standard. The frequency of this output is the subcarrier frequency divided by 455/2. This frequency has been selected to eliminate cross-talk between the horizontal scanning frequency and the color subcarrier.

Burst Flag Generator (MI-40202-A)

This unit is used for keying in the color subcarrier burst. Its output consists of a series of horizontal pulses which key the burst of subcarrier onto the back porch of the blanking signal in the colorplexer. These pulses are suppressed during the vertical synchronizing interval so that no burst is keyed at this time.

Step #2 Equipment

COLOR BAR AND LOCAL ORIGATION EQUIPMENT

Qty.	Description
1	Color Frequency Standard
1	Burst Flag Generator
2	Type 580-D Power Supplies
1	Type TG-2A Studio Sync Generator (includes Dot and Gating outputs)
2	Type BR-84D Cabinet Rack
1	Type WA-1D Studio Color Bar Generator
1	TX-1B Colorplexer
1	Sync Generator Changeover Switch
1	Changeover Switch Remote Control Panel
1	Aperture Compensator (for TX-1B)

3-VIDICON 16MM COLOR FILM AND SLIDE EQUIPMENT

1	Type TK-26A Three-Vidicon Color Film & Slide Camera Chain (Includes: camera proper, camera auxiliary, control panel, processing amplifier, colorplexer, master monitor, color monitor, power supplies, console housings and cables)
1	Type TP-12 Three-Vidicon Multiplexer, including control panel
2	Type TP-6BC Film Projectors, 16mm, including pedestal, lens and accessories
1	TP-3C Dual Disc Slide Projector
1	TA-3A Video Distribution Amplifier
1	TA-4A Video Distribution Amplifier
2	Type BR-84D Cabinet Rack



FIG. 9. View of the advanced design Sync Generator which has reduced the rack space to one-third that occupied by former designs. Providing extra stability, small size and combining all sync functions in a single chassis, it is ideal for color TV applications. It includes a built-in Genlock, dot generator, grating generator and regulated power supply.

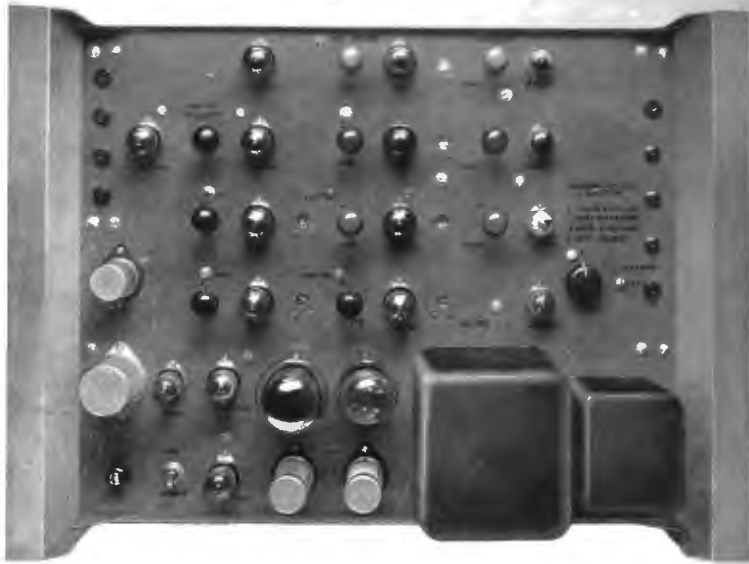

FIG. 10. The Color Bar Generator is required for steps #2 and #3 and is just as important to Color TV as the Monoscope Camera is for Monochrome. The Color Bar Generator provides a standard signal free of residual imperfections.

TG-2A Sync Generator

The TG-2A is an entirely new Synchronizing Generator designed especially for color operation. Miniature tubes and other miniaturization techniques have been used to reduce the size of this new unit to approximately one-third that of previous models. Providing extra stability, small size and combining all sync functions in a single chassis, it is ideal for color TV applications. It includes a built-in Genlock, dot generator, grating generator and regulated power supply.

Sync Generator Changeover

Most stations operating today are equipped with one or more TG-1A Generators. It is possible to modify the TG-1A Sync Generator for color operation by means of modification kit, MI-40405. This kit contains all of the necessary parts and a complete set of instructions for making this modification. By modifying the station's original generator for color it is possible to use either it or the newly installed sync generator for either monochrome or color. This provides for emergency opera-

WP-33B POWER SUPPLY (MONO CAM NO 1)	WP-33B POWER SUPPLY (MONO CAM NO 2)	TA-1A DIST AMP	BLANK TA-3A DA NO 2 TA-3A DA NO 3 TA-3A DA NO 4	COLOR BAR GENERATOR
WP-33B POWER SUPPLY (MONO CAM NO 1)	WP-33B POWER SUPPLY (MONO CAM NO 2)	TG-2A SYNC GENERATOR	TA-5D NO 1 STAB AMP MODIFIED (NET)	APERTURE COMP.
580-D POWER SUPPLY (MONO CAM NO 1)	580-D POWER SUPPLY (MONO CAM NO 2)	BLANK	BLANK VIDEO JACK PANEL VIDEO JACK PANEL	TX-1B COLORPLEXER (COLOR BARS)
CURRENT REGULATOR (MONO CAM NO 1)	CURRENT REGULATOR (MONO CAM NO 2)	580-D POWER SUPPLY (STAB AMP NO 1) NET	BLANK TA-5D NO 2 STAB AMP MODIFIED (LINE)	COLOR SIGNAL ANALYZER
WP-33B POWER SUPPLY (FILM CAMERA MONO)	WP-33B POWER SUPPLY (TA 3A'S)	580-D POWER SUPPLY (STAB AMP NO 2) LINE	FILM CAMERA CONTROL CHASSIS	LINEARITY CHECKER
WP-33B POWER SUPPLY (FILM CAMERA MONO)	WP-33B POWER SUPPLY (PV MON)	580-D POWER SUPPLY (TA 1A)	FILM CAMERA DEFLECTION CHASSIS	BLANK
				580-D POWER SUPPLY (COLORPLEXER TEST)

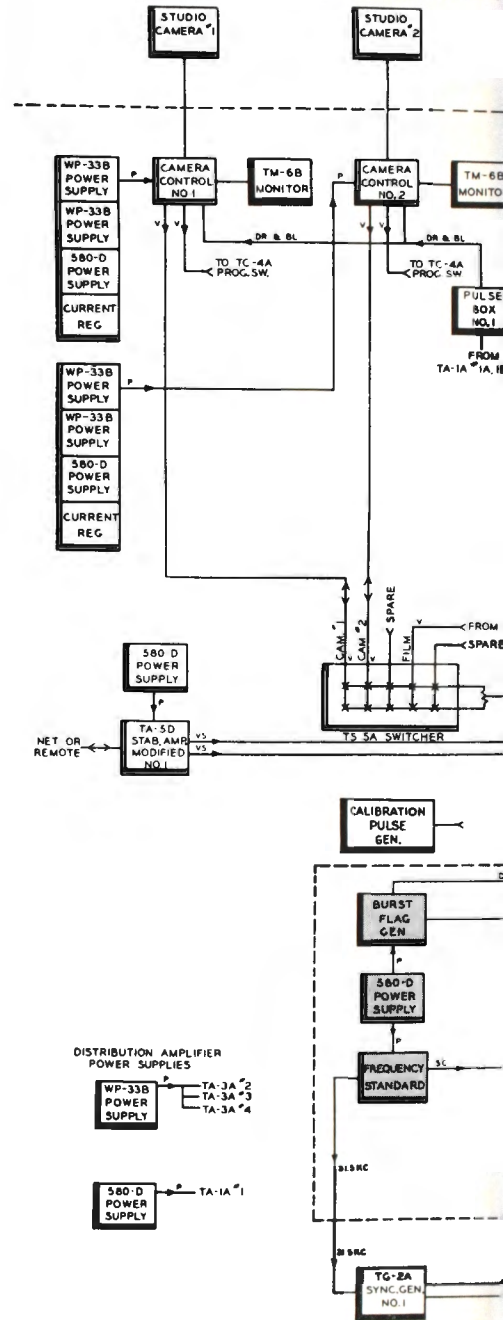

FIG. 11 (left). Rack layout for the equipment shown in Fig. 12. As shown here the color units added in Part I of Step 2 are all mounted in one rack. If a new TG-2A Sync Generator is added at this time (as suggested in the equipment list) it will be necessary to add a sixth rack.

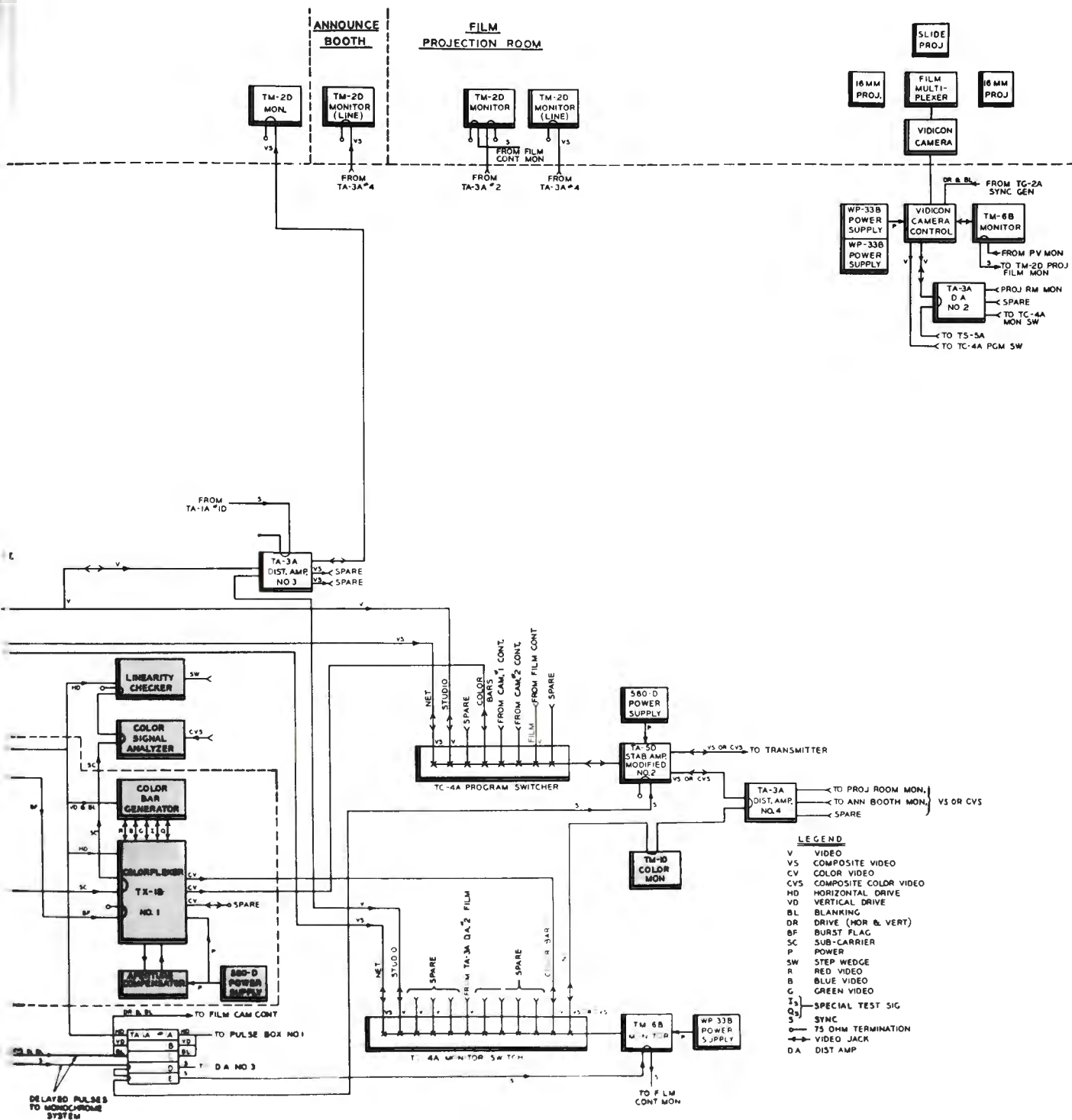

FIG. 12. Block diagram showing how the Color Bar and Local Origination equipment added in Part I, Step 2, can be integrated with the monochrome and color facilities of a Step 1 station. The units added in this step are indicated by shaded blocks. Only one TG-2A Sync Generator (the one originally installed for monochrome) is shown in this diagram. A second TG-2A is included in the list of equipment and is recommended when the color bar pattern is to be put on the air. Its use provides for easier change between monochrome and color programming, as well as providing a spare for emergency. The block diagram on page 43 shows how the second sync generator may be inserted in the system. It will be noted that the output of the TG-2A Sync Generator must feed delayed pulses to the monochrome system if smooth switching between color and monochrome is to be accomplished. The proper handling of pulse signals in a color system will be discussed in detail in a forthcoming article.

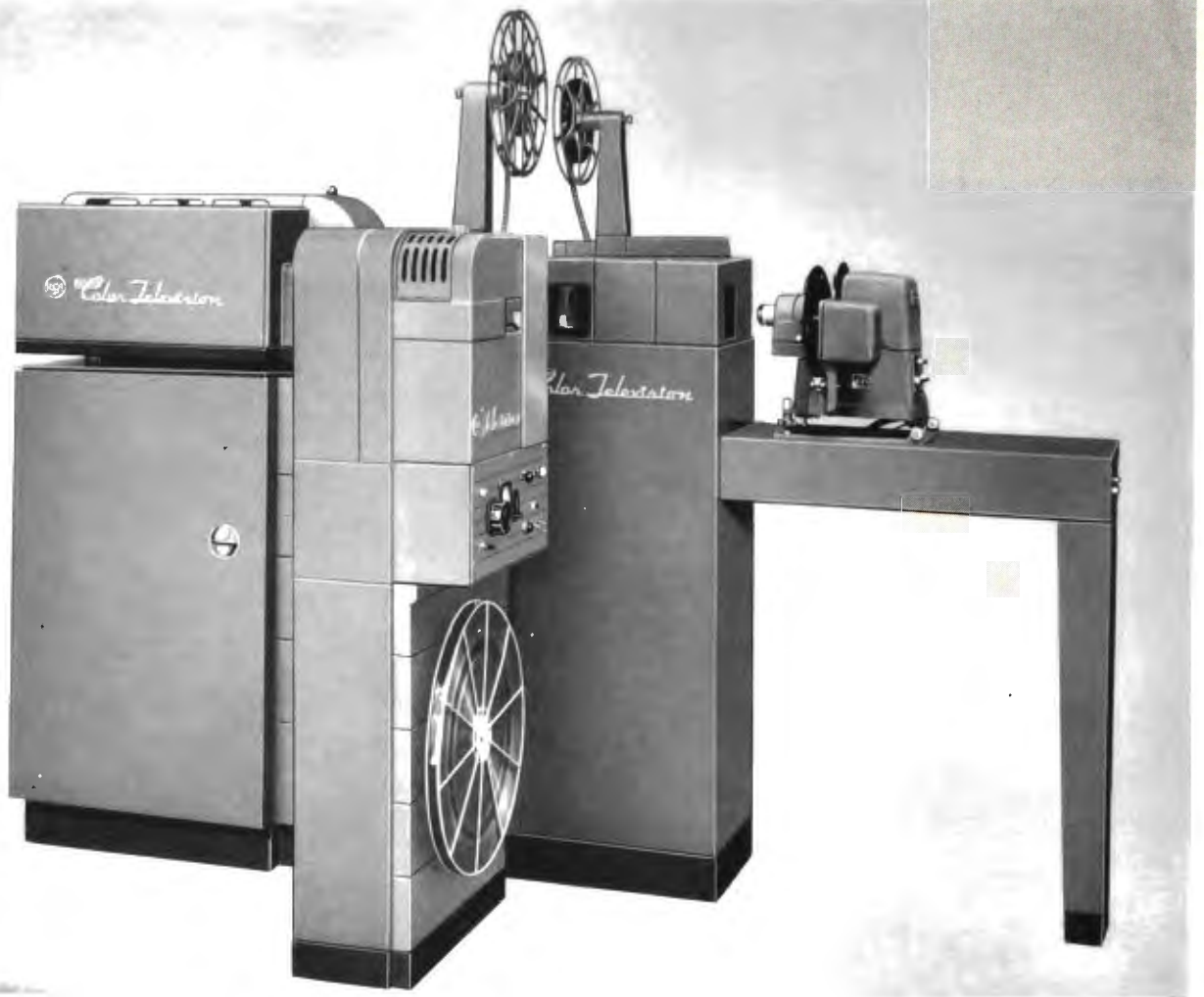

FIG. 13. Grouping of camera and projector equipment for telecasting color slides and films. At the left is the TK-26A "3-V" Color Film Camera; in the center is the TP-12 Optical Multiplexer; at the right is a TP-3C Dual Slide Projector; in the foreground is one TP-6BC 16mm Film Projector; a second TP-6BC is on the other side of the multiplexer and only the reel-arm is visible.

tion in case of failure in either while on the air. To facilitate changeover a special Sync Generator Changeover Switch is included in the list of equipment as well as a Remote Panel for controlling the switch from the console.

WA-1D Studio Color Bar Generator

The WA-1D, when fed into a standard color system which includes a TX-1B Colorplexer, produces a standard color signal pattern containing bars of various identified colors (white, yellow, blue, green, cyan, magenta, purple) plus patterns corresponding to I and Q signals. This signal pattern, which corresponds somewhat to that of the Monoscope Camera in monochrome, is of great usefulness in checking the whole color system. In conjunction with the signal analyzer it is used for precise alignment of the colorplexer modulator circuits. As a source of color signal for

routine measurements throughout the system it is unsurpassed.

The WA-1D Generator has five output channels—green, red, blue, I and Q. These outputs are fed to corresponding inputs on the RCA TX-1B colorplexer. The matrixing section of the colorplexer combines these signals and feeds them to the I and Q modulators at the proper polarity and amplitude to produce a colorplexed bar signal at the output of the colorplexer.

The test pattern from the color bar generator can be used most effectively by viewers in their homes as well as by station engineers and servicemen. In order to adjust his set for best color balance, the viewer merely has to adjust the color or chroma control until the color bars in the top row are vivid and pleasing to the eye. Then he must adjust the phase or hue control to achieve the best yellow hue in the second bar from the left. If the hue control

is out of adjustment on one side or the other, the yellow bar will appear either greenish or too orange. If the yellow bar is set properly in this way, all the other colors normally fall into correct adjustment.

TX-1B Colorplexer

The TX-1B Colorplexer is the "heart" of the RCA Color system. It performs all the matrixing and multiplexing operations necessary to process the red, green, and blue signals provided by a color camera to produce a signal conforming to the FCC signal specifications.

The colorplexer has inputs for color signal sources such as a color bar generator, a live camera, or a film chain. A switch on the colorplexer enables the operator to switch between the live or film camera and the bar generator. An automatic "carrier balance" unit which largely eliminates color "drift" problems is furnished with each colorplexer.

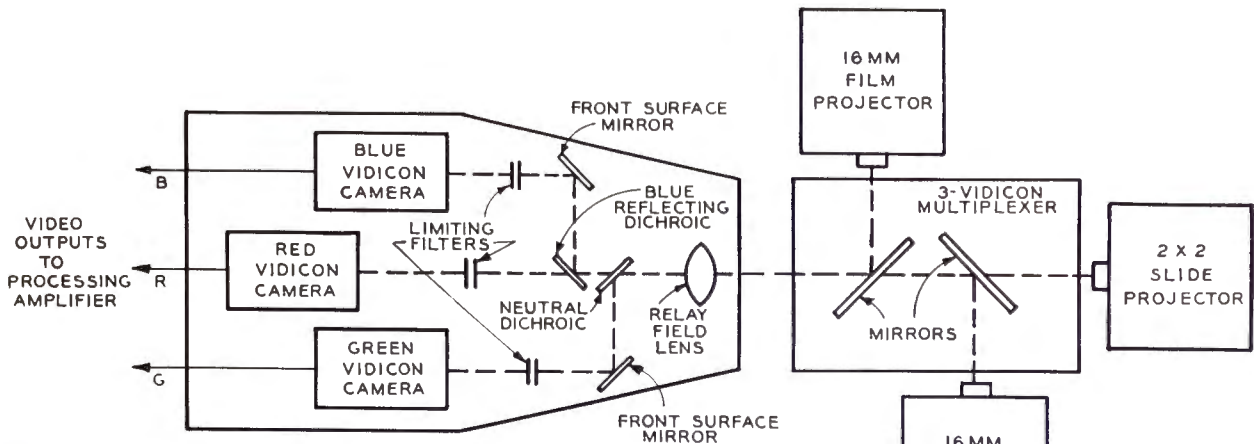

FIG. 14. Diagram of the camera-projector equipment grouping shown in Fig. 13. Hinged mirrors in the multiplexer direct a picture from either of the film projectors, or the slide projector, into the field lens of the 3-V Camera. Position of mirrors can be controlled from a remote point thus allowing push-button selection of picture sources. Dichroic mirrors and color filters in the 3-V camera divide the light into three color components and direct these components into three vidicon cameras as shown. Registration is relatively easy to achieve and the system is very stable in operation.

STEP 2 — PART II

Color Film and Slide Equipment

The major equipment units needed for originating color slide and film pictures are listed in the lower part of the box on Pg. 37. The list includes not only the 3-V Camera Chain but also a multiplexer, two film projectors, a slide projector and video distribution equipment. The functional arrangement of this equipment with the monochrome equipment, and the color equipment installed in previous steps, is indicated in the block diagram of Fig. 17. The 3-V Camera could, of course, be used with just one film projector or a single slide projector, in which case the multiplexer is not required. Or it might, if desired, be

installed originally with one film projector and one slide projector. However, the provision of two film projectors provides for continuity on multi-reel shows as well as adding flexibility in programming.

The ease with which the 3-V Camera can be multiplexed is one of its outstanding features. Color cameras of the flying spot scanner type are usually difficult to multiplex. Also they require a special type of projector using a complicated arrangement of rotating mirrors or prisms. The 3-V Camera can be multiplexed with the same ease as a monochrome film camera. And it can be used with the same type of projectors as used for monochrome. Stations having RCA TP-6 Projectors can use

these for color by slightly modifying them for long light application. (The new RCA TP-6BC Projector is designed for long light application—can be used for either color or monochrome.)

TK-26A Color Film Camera

The RCA TK-26A color film camera employs three RCA 6326 Vidicons, one for each of the primary colors of the color film being transmitted. These vidicons "look" at a real image produced by the projector and reflected by the multiplexer to a field lens in the camera. By use of a separate lens at each camera and appropriate choice of dichroics and color shaping filters, one camera sees only the red com-

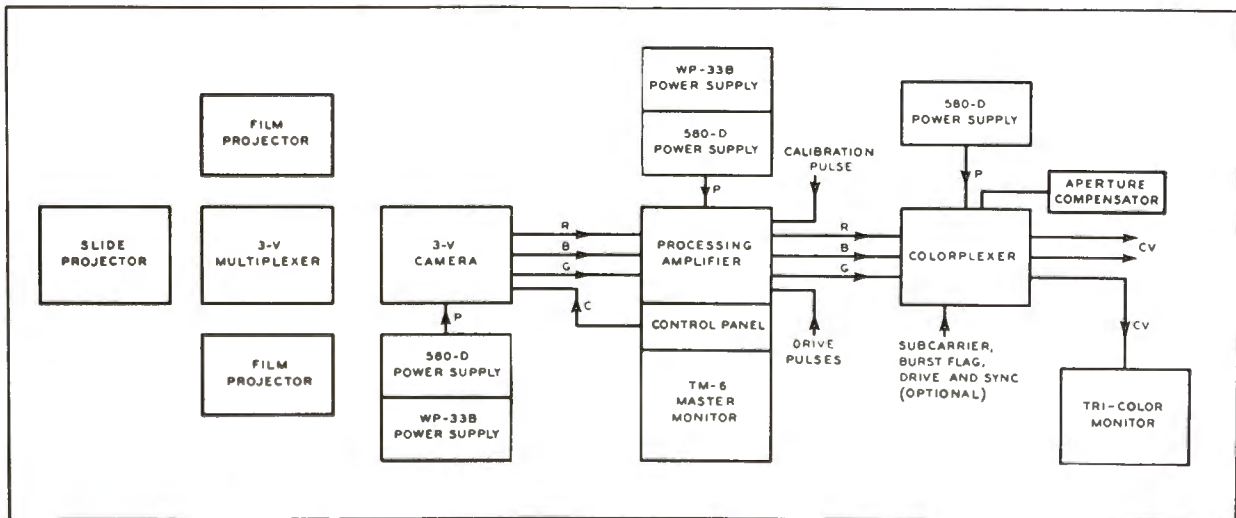

FIG. 15. Simplified block diagram showing the elements of the 3-Vidicon Color Film system.

ponent. the second camera sees only the green component, and the third the blue component of the color image. (See diagram of Fig. 14.)

The three identical vidicon camera sub-chassis are located, together with the light-splitting optics, in the top part of the camera cabinet. Mechanical alignment of the three sub-chassis is easily achieved by thumbscrew adjustment. The "in line" arrangement of the camera sub-chassis also simplifies this initial set-up. Final precise registration is easily achieved electronically, and once registered, there is excellent stability of registration. In day-to-day operation, only minor touch-up of controls will be necessary.

High resolution and maximum stability is obtained in this 3-vidicon system. Gamma is ideal—needs virtually no correction; color fidelity approaches the high quality standards set by RCA's color studio camera. Use of the vidicon tube also provides a very high signal-to-noise ratio in both the color and the compatible monochrome picture. This feature is particularly important, especially in the first few years of color operation when color programs will be viewed on a great number of monochrome sets.

Camera Control Console

The 3-V Camera Control Equipment is normally mounted in a control console as shown in Fig. 16. The control position

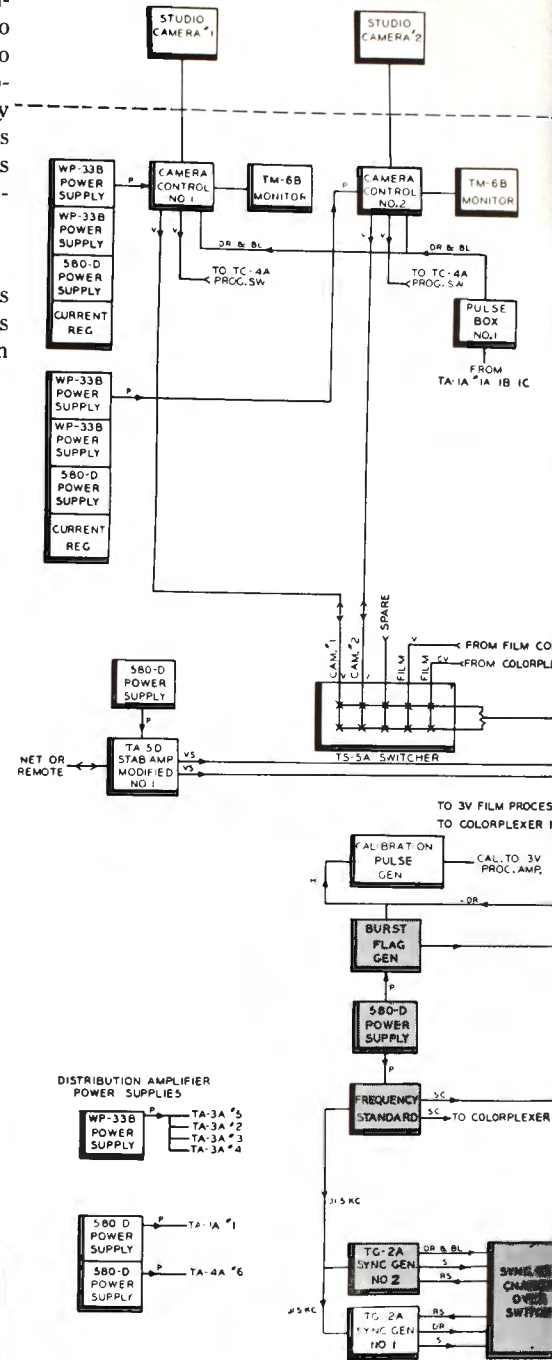

FIG. 16 (left). The complete 3-V Camera Control equipment includes a TM-6C Monochrome Monitor, a 19-inch Console containing the camera control panel and processing amplifier and a Type TM-10B Color Monitor. These three units may be grouped together as shown here. Or the color monitor may be suspended from the wall or ceiling for better visibility (by producer, technical director, etc.). The two console units can be located separate from the monochrome control units or mounted in line with them. When desired the control panels can be furnished for rack mounting as shown in Fig. 28, page 51.

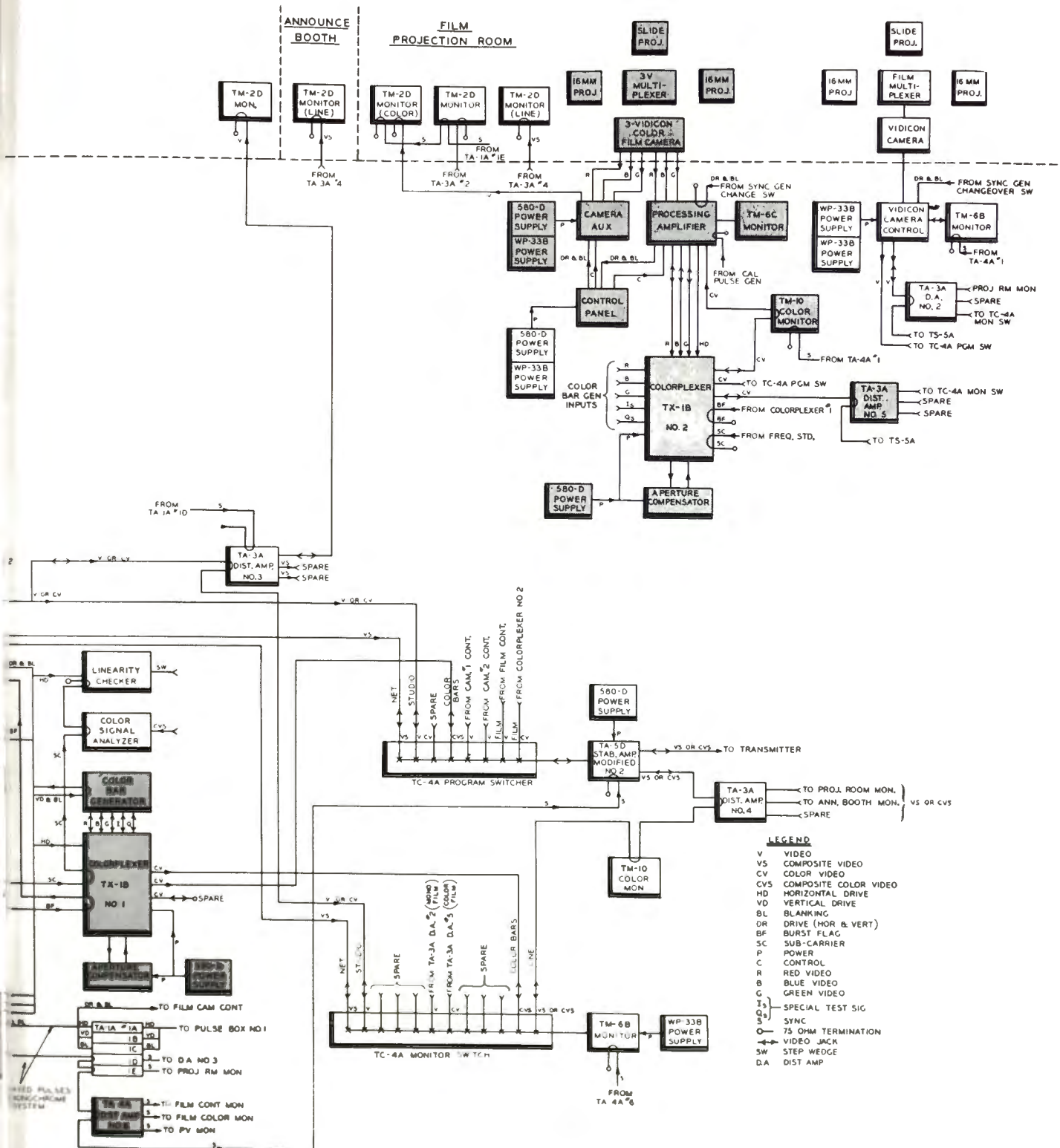

FIG. 17. Simplified block diagramming showing how the color equipment added in Step 2 can be integrated with the original monochrome equipment (and the Step 1 color equipment) of the typical station. Equipment of both Part I and Part II of Step 2 is shown in shaded blocks. Two colorplexers are included in Step 2, one with the "Color Bar Equipment" and a second with the 3-V Film Equipment. Although it would be possible to operate with one colorplexer, a second is recommended so that (a) bar output will be available for system checking without having to shut down film operation, and (b) so that an emergency spare is always available. An aperture compensator is provided with each colorplexer in order to facilitate emergency operation. This, together with the provision of a second sync generator and emergency changeover switch, provides a large degree of protection against loss of air time due to equipment failures.

580-D POWER SUPPLY (STAB AMP NO1)	WP-33B POWER SUPPLY (3V FILM)	WP-33B POWER SUPPLY (MONO CAM NO1)	WP-33B POWER SUPPLY (MONO CAM NO2)	TA-1A DIST AMP	TA-3A D A NO5	COLOR BAR GENERATOR	APERTURE COMP
580-D POWER SUPPLY (STAB AMP NO2)	WP-33B POWER SUPPLY (3V FILM)	WP-33B POWER SUPPLY (MONO CAM NO1)	WP-33B POWER SUPPLY (MONO CAM NO2)	TG-2A SYNC GENERATOR	TA-3A D A NO2	APERTURE COMP	TX-1B COLORPLEXER (3V)
580-D POWER SUPPLY (TA-1A)	580-D POWER SUPPLY (3V FILM)	580-D POWER SUPPLY (MONO CAM NO1)	580-D POWER SUPPLY (MONO CAM NO2)	TG-2A SYNC GENERATOR	TA-3A D A NO3	TX-1B COLORPLEXER (COLOR BARS)	BLANK
BLANK	580-D POWER SUPPLY (3V FILM)	CURRENT REGULATOR (MONO CAM NO1)	CURRENT REGULATOR (MONO CAM NO2)	TG-2A SYNC GENERATOR	TA-5D NO1 STAB AMP MODIFIED (NET)	COLOR SIGNAL ANALYZER	VIDEO JACK PANEL
	580-D POWER SUPPLY (3V FILM)	WP-33B POWER SUPPLY (MONO CAM NO1)	WP-33B POWER SUPPLY (MONO CAM NO2)	FREQUENCY STANDARD	BLANK	LINEARITY CHECKER	VIDEO JACK PANEL
	580-D POWER SUPPLY (COLORPLEXER) 3V	WP-33B POWER SUPPLY (FILM CAMERA MONO)	WP-33B POWER SUPPLY (TA-3A'S)	BURST FLAG GENERATOR	TA-5D NO2 STAB AMP MODIFIED (LINE)	TA-4A D A NO6	BLANK
	580-D POWER SUPPLY (COLORPLEXER) TEST	WP-33B POWER SUPPLY (FILM CAMERA MONO)	WP-33B POWER SUPPLY (PV MON)	BLANK	FILM CAMERA CONTROL CHASSIS	BLANK	VIDEO JACK PANEL
	BLANK			SYNC GEN CHANGE SWITCH	FILM CAMERA DEFLECTION CHASSIS	CALIB PULSE GENERATOR WA-9A	BLANK



FIG. 18. A. R. Hopkins, Manager of RCA Broadcast Equipment Marketing and C. G. Nopper, Chief Engineer of WMAR-TV, Baltimore, are inspecting the control panel of the "3-V" Color Film Camera. This view of the 3-Vidicon Camera pedestal shows the location of vidicon enclosure atop pedestal, local control panel, and camera auxiliary panel.

FIG. 19 (above). Rack layout of the equipment shown in Fig. 17. At this point four racks have been added (to the original monochrome layout) to house the color equipment. Actually this equipment could have been mounted in three racks (note blanks). However, the arrangement shown has the advantage of isolating the power supplies and is advantageous when further expansion is undertaken.

includes (1) a TM-6C Master Monitor mounted in a 13-inch console housing, and (2) a 19-inch console housing, in which the camera control panel and the processing amplifier may be mounted. This 19-inch master console housing is designed to mount the camera control panel in the indented desk section and the processing amplifier in the top sloping portion of the console. The processing amplifier performs a number of functions previously requiring several other units. Integration of these electrical functions in a single unit results in a simple, space-conserving, low cost system. Use of this design allows set-up time to be substantially reduced. A large reduction in power required as well as increased tube life due to extremely conservative operation of tubes reduces costs, at the same time improving performance and overall system quality.

The basic circuit elements in the processing amplifier are three plug-in video amplifiers which perform the following functions: cable compensation, video amplification, blanking insertion, shading insertion, feedback clamping, linear clipping, gamma correction and output amplification.

FIG. 20. Floor layout for the 3-V Camera and Projector grouping shown in Fig. 13. This diagram is useful in planning the necessary space for this equipment. Outlines of equipment units are shown as well as a suggested system of trenches for interconnecting cables. Physical dimensions and weights of all RCA color equipment units are shown in the table on page 55.

A fourth plug-in unit serves as the video section of an electronic switcher which is an integral part of the main chassis. The switcher, used with the TM-6C Master Monitor, provides an individual or combined presentation of red, blue and green video.

To complete the control function a TM-10B Color Monitor is needed. This may be suspended either from the wall or ceiling or set upon the flat top of the master console housing as space requirements dictate.

Several alternative arrangements are available to stations that wish to integrate their color and monochrome equipment or are otherwise limited by space. For example, all of the 3-V color film control equipment may be rack mounted. In this case a rack mounted control desk and accessory kit, MI-40415, is available to provide desk space at the rack location. In this case it is recommended that the TM-10B Color Monitor be mounted in an adjoining rack at approximately the level of the monochrome TM-6C Master Monitor. (See Fig. 28, Pg. 51.)

Rack Equipment

Rack-mounted units which complete the 3-V Camera Chain include a TX-1B Colorplexer, an associated aperture compensator and a set of power supplies (two WP-33B's and three 580-D's). The colorplexer combines the outputs from the processing amplifier with the subcarrier to form a composite video signal. It does this in two operations as follows: (1) it cross-mixes the R, G, and B signals to form the luminance (or monochrome) signal and the two chrominance signals and (2) it multiplexes these signals with the subcarrier to produce a composite color signal suitable for feeding the transmitter.

Two video jack panels are also provided. These, together with the rack-mounted units of the 3-V Camera Chain, including power supplies can be mounted in two

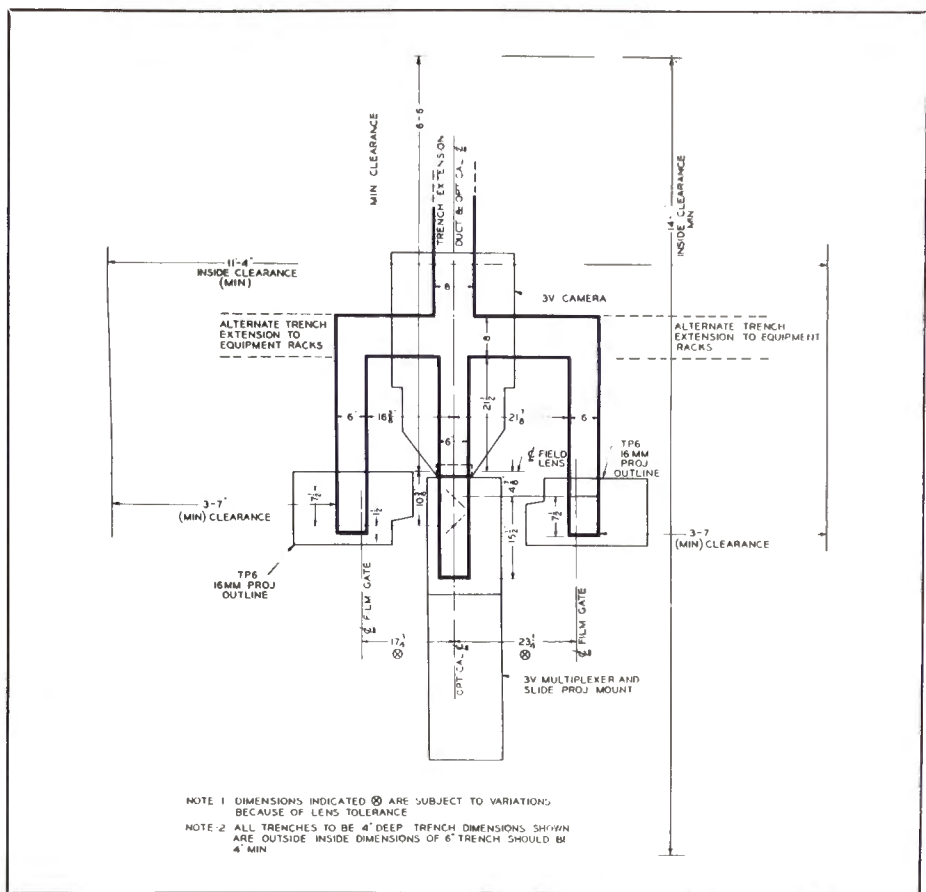

standard cabinet racks. A typical rack arrangement for a Step 2 station is shown in Fig. 19.

TP-6BC Film Projectors

Two TP-6BC Film Projectors are listed in the equipment to be added in Step 2. One of the important features of the TK-26A 3-vidicon film camera system is that it utilizes the excellent storage characteristic of the vidicon tube. This allows operation with intermittent type film projectors of the type with which most television operators are already familiar. Use of the intermittent type projector means that, while the sync generator is phased from the color subcarrier crystal as required in a color system, the projectors can operate directly from the power line. If available projectors are used it is necessary to modify these projectors for long application. The RCA TP-6BC professional projectors, however, can be used in the 3-vidicon system without modification since the long application feature has been incorporated in its design.

The RCA TP-6BC projectors provide an ample reserve of light to produce the best possible pictures from films of the highest density.

TP-3C Slide Projector

A TP-3C Slide Projector is recommended for use with the Step 2 equipment. It allows the station to make station breaks in color and to present color commercials on standard 2 x 2 color slides. These are easily made up by mounting Kodachrome color transparencies in standard mountings. The TP-3C Projector accommodates 12 slides in two discs arranged for optical fade between slides.

TP-12 Multiplexer

The TP-12 Multiplexer (which can be seen in the center of the assembly in Fig. 13) provides the optical system required to project a number of film sources into a single 3-V camera. Using mirrors, the multiplexer provides for two film projectors (16mm or 35mm) and a single 2 x 2-inch dual-disc slide projector. Selection of film or slide sources can be remotely controlled. Each of the two mirrors in the multiplexer is hinged so that they will fold out of the way as required (see the block diagram, Fig. 14). The movement is electrically activated so that the proper combination is obtained by operation of projector controls. The image from any of the projectors can thus be relayed to the field lens in the 3-vidicon camera.

STEP 3 - Addition of Equipment For Telecasting Live Color Programs Originated in Your Own Studios

The third and final step in color is the installation of equipment for telecasting live studio color programs. Eventually, nearly every station will need such equipment, not only for studio color originations but also for pickup of local events. Many stations will want a live color camera immediately in order to be able to do local commercials in color. Experience of stations now operating with local color indicates that many color commercials are best when done "live".

Most stations, however, will not immediately need elaborate color studio setups. The equipment recommended in Step 3 provides the very minimum in live studio

Step #3 Equipment	
COLOR STUDIO CAMERA EQUIPMENT	
Qty.	Description
1	TK-41 Color Studio Camera Chain (Includes: color camera, viewfinder, processing amplifier, colorplexer, master monitor, color monitor, power supplies, console housings and cables)
1	Cradle Head
1	TD-4A Heavy Duty Pedestal
2	Type BR-84 Cabinet Rocks
1	TA-4A Pulse Distribution Amplifier

facilities, viz., a single camera and necessary associated equipment. With this equipment simple studio shows and live commercials can be telecast in color and experience gained by station personnel in all phases of color operation.

The equipment listed in the box at left provides the ideal "minimum" setup for live studio color. When this equipment is added to Steps #1 and #2 facilities, the station can program from four different sources, (1) network, (2) films, (3) slides and, (4) studio. The arrangement of a Step #3 station is shown pictorially in Fig. 21 and functionally in Fig. 25.

The major item added in Step #3 is a

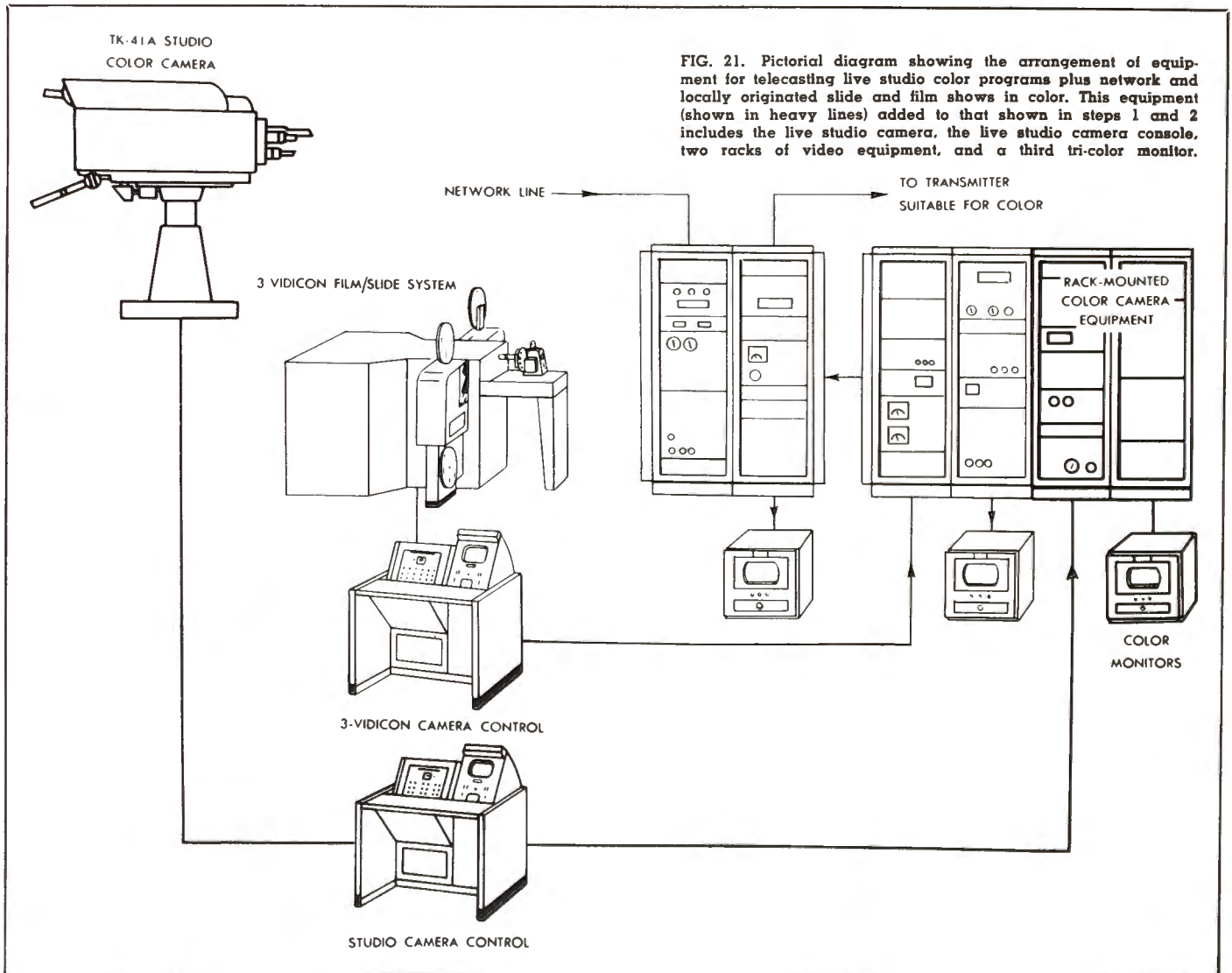

FIG. 21. Pictorial diagram showing the arrangement of equipment for telecasting live studio color programs plus network and locally originated slide and film shows in color. This equipment (shown in heavy lines) added to that shown in steps 1 and 2 includes the live studio camera, the live studio camera console, two racks of video equipment, and a third tri-color monitor.

FIG. 22. Closeup view of the "all electronic" RCA Color Camera, now in regular use at TV stations. This color camera is unsurpassed in the picture quality and detail it provides. The TK-41 camera chain is the major item in step #3.



TK-41 Color Studio Camera. The complete color camera chain includes color camera, viewfinder, camera control, processing amplifier, color monitor, colorplexer and necessary rack mounted equipment.

The camera equipment supplied in Step #3 is identical in every respect with that used in the largest multiple camera setups. Thus the station starting with just one studio camera is nevertheless assured of the very highest quality, and has assurance of being able to add more cameras as desired without obsolescence of any previously purchased equipment.

TV stations desiring to install Step #3 live facilities, ahead of the film facilities of Step #2, can do so anytime after the color bar and local origination (sync generator) equipment of Step #2 is installed. This is mentioned since some stations may choose to start programming with live color and add color film facilities later.

TK-41 Color Camera

The TK-41 color camera is certainly one of the finest, high-quality equipments ever designed for TV station use. It is all-electronic, and employs the latest in circuitry such as the unique processing amplifier which has resulted in compact auxiliary equipment, improved operating stability and economical operation.

The principal components of the TK-41 Color Studio Camera Chain are shown in the block diagram of Fig. 23. The TK-41 features considerable space and cost saving advantages over previous color chains.

As in the standard monochrome camera, the optical system, the deflection circuits, the pickup tubes and the preamplifiers are located in the three-tube color camera. The

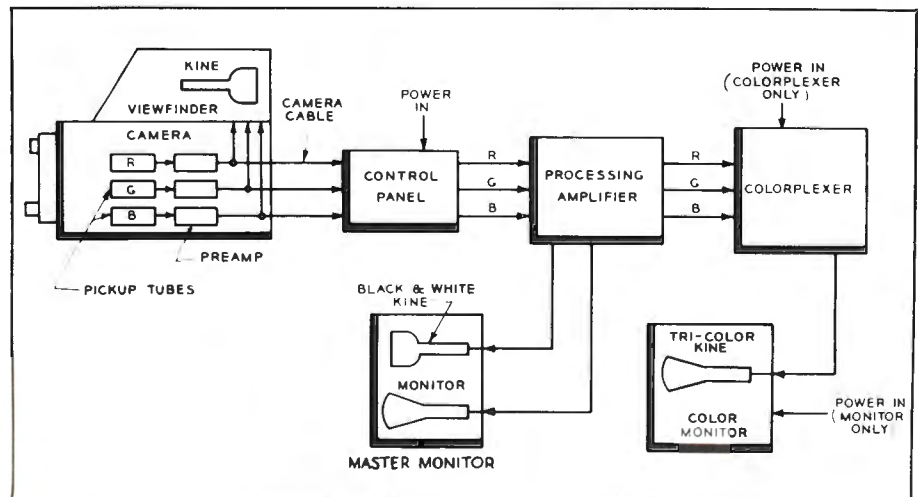

FIG. 23. Block diagram of the TK-41 Color Camera Chain. The chain incorporates the newly designed Processing Amplifier which combines all signal processing functions, thereby saving more than half the rack space formerly required.

turret on the camera is designed to accommodate four standard television lenses (the same as those used on monochrome cameras).

The color camera proper contains a light splitting optical system and three separate image orthicon tubes to provide red, blue, and green signals, three video preamplifiers, horizontal and vertical deflection circuits for the image orthicons, and power supplies for these deflection chassis. A selsyn-operated iris control is also part of the optical system and serves as a gain control as well. The electronic viewfinder is comprised of a 7TP4 kinescope with necessary deflection and video circuits to provide a picture for the camera operator. The plug-in video preamplifiers and the deflection circuits are arranged for accessibility, ease-in-operation and maintenance.

The camera proper, with attached viewfinder can be mounted on the TD-4A studio pedestal. The weight of the camera is accurately balanced on a new heavy-

duty cradle-type tilt-head. This enables it to be panned and tilted easily in any direction.

Proper control of the camera is simple and straight forward. Once initial set-up is completed only two operating controls are needed: (1) remote iris control used as a master gain control and (2) master pedestal control which causes all three pedestals to track up and down together. Station operators and engineers familiar with monochrome camera control will find it easy to master these color television controls.

Viewfinder

The viewfinder provides the cameraman with a high quality monochrome picture on a 7-inch kinescope for checking picture composition and optical focus during operation. The camera registration may be checked at the camera position since it is possible to view the primary color picture signals, both separately or in various combinations on the viewfinder.

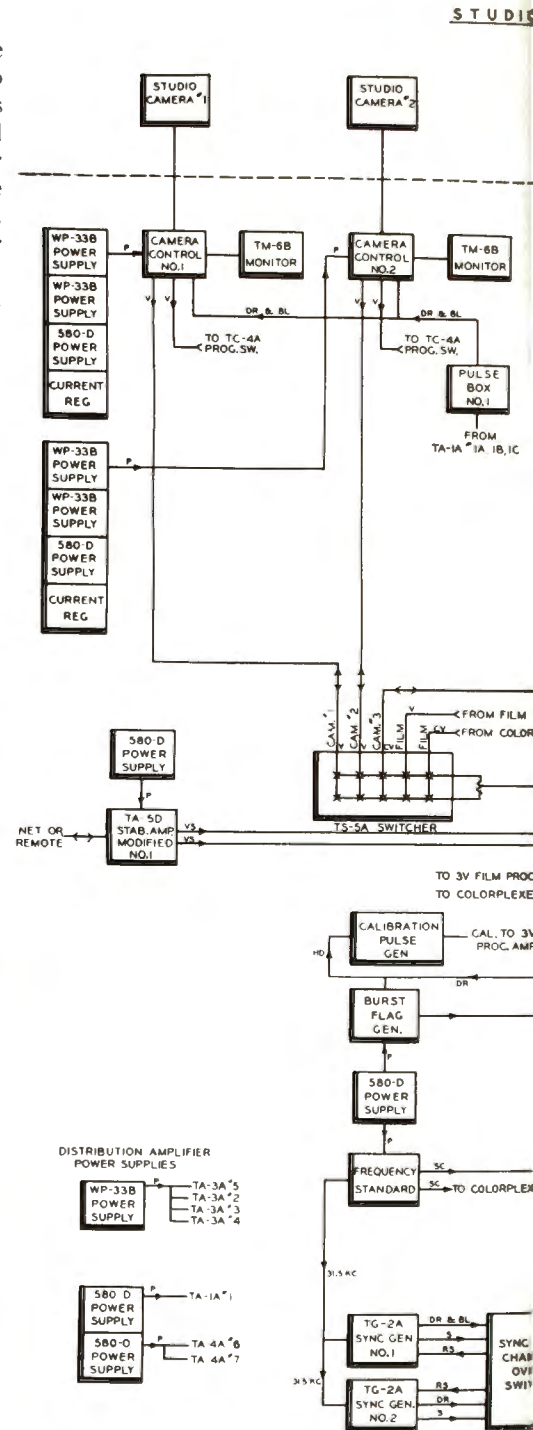
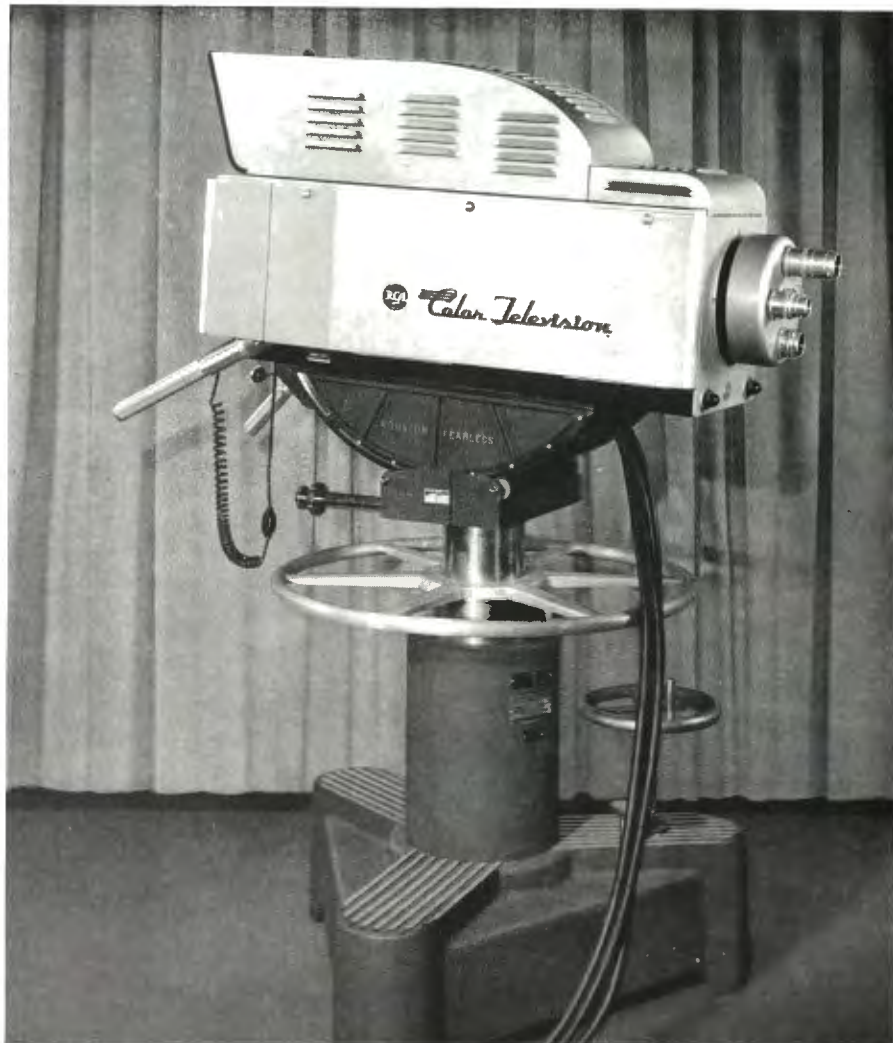

FIG. 24 (left). The TK-41 Studio Color Camera mounted on a TD-4A Studio-type Pedestal. The weight of the camera is carefully balanced on a new heavy-duty cradle-type head. This enables it to be panned and tilted easily. Although the color camera is heavier and somewhat larger than the standard monochrome camera it is almost as maneuverable. On limited action shows it is easily handled by one man.

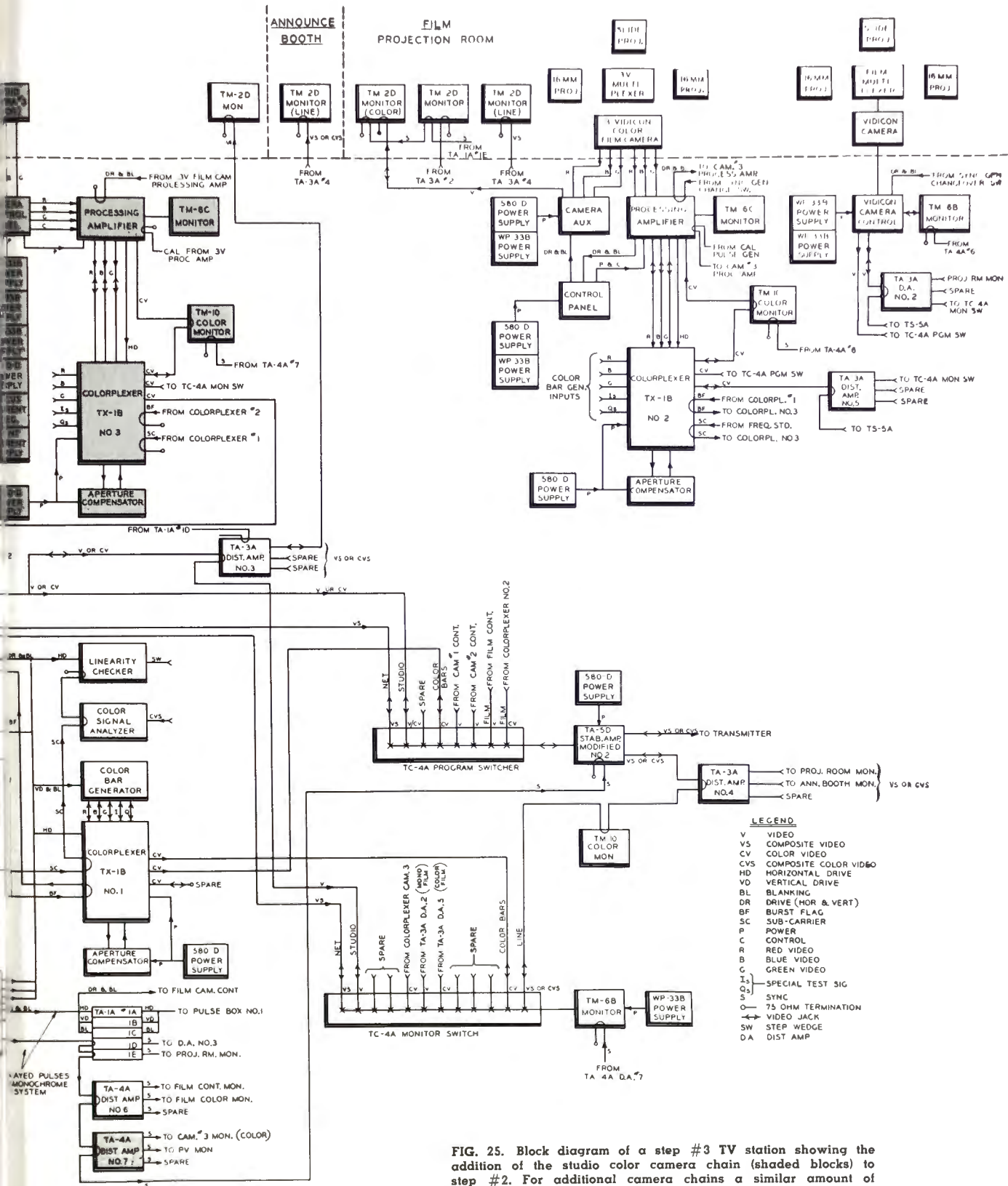

FIG. 25. Block diagram of a step #3 TV station showing the addition of the studio color camera chain (shaded blocks) to step #2. For additional camera chains a similar amount of equipment will be required. Suitable switching facilities are shown for handling only the equipment indicated. For more extensive operations, the TS-11 or TS-20 switchers may be employed.

WP-33B POWER SUPPLY (COLOR CAMERA)	580-D POWER SUPPLY (STAB AMP NO1)	WP-33B POWER SUPPLY (3V FILM)	WP-33B POWER SUPPLY (MONO. CAM. NO.1)	WP-33B POWER SUPPLY (MONO. CAM. NO.2)	TA-1A DIST. AMP.	TA-3A DA. NO.5	COLOR BAR GENERATOR	APERTURE COMP
WP-33B POWER SUPPLY (COLOR CAMERA)	580-D POWER SUPPLY (STAB AMP NO 2)	WP-33B POWER SUPPLY (3V FILM)	WP-33B POWER SUPPLY (MONO. CAM. NO.1)	WP-33B POWER SUPPLY (MONO. CAM. NO.2)	TG-2A SYNC. GENERATOR	TA-3A DA. NO.2	APERTURE COMP	TX-1B COLORPLEXER (3V)
WP-33B POWER SUPPLY (COLOR CAMERA)	580 D POWER SUPPLY (TA-1A)	580-D POWER SUPPLY (3V FILM)	580-D POWER SUPPLY (MONO. CAM. NO.1)	580-D POWER SUPPLY (MONO. CAM. NO.2)	TG-2A SYNC. GENERATOR	TA-3A DA. NO.4	TX-1B COLORPLEXER (COLOR BARS)	VIDEO JACK PANEL
580-D POWER SUPPLY (COLOR CAMERA)	BLANK	580-D POWER SUPPLY (3V FILM)	580-D POWER SUPPLY (MONO. CAM. NO.1)	580-D POWER SUPPLY (MONO. CAM. NO.2)	FREQUENCY STANDARD	TA-5D NO.1 STAB. AMP MODIFIED (NET)	COLOR SIGNAL ANALYZER	VIDEO JACK PANEL
FOCUS CURRENT REGULATOR		580-D POWER SUPPLY (3V FILM)	CURRENT REGULATOR (MONO. CAM NO.1)	CURRENT REGULATOR (MONO. CAM. NO.2)	BURST FLAG GENERATOR	BLANK VIDEO JACK PANEL	LINEARITY CHECKER	VIDEO JACK PANEL
CENTERING CURRENT GENERATOR		580-D POWER SUPPLY (COLORPLEXER) 3V	WP-33B POWER SUPPLY (FILM CAMERA MONO)	WP-33B POWER SUPPLY (TA-3A'S)	BLANK	BLANK VIDEO JACK PANEL	TA-4A DA. NO.6	APERTURE COMP
580 D POWER SUPPLY COLORPLEXER CAMERA		580-D POWER SUPPLY (COLORPLEXER) TEST	WP-33B POWER SUPPLY (FILM CAMERA MONO)	WP-33B POWER SUPPLY (PV MON)	SYNC GEN. CHANGE SWITCH	TA-5D NO.2 STAB. AMP MODIFIED (LINE)	TA-4A DA. NO.7	TX-1B COLORPLEXER (COLOR CAMERA)
		BLANK				FILM CAMERA CONTROL CHASSIS	BLANK	APERTURE COMP
						FILM CAMERA DEFLECTION CHASSIS	CALIB PULSE GENERATOR WA-9A	BLANK

FIG. 26 (above). Suggested rack layout of the complete monochrome and color equipment shown in Fig. 25. The rack-mounted color equipment items added in Step 3 require about one and a half racks. However, by placing the colorplexer in space left blank in Step 2 (see Fig. 19, page 44) it is possible to accommodate all equipment on just one rack more than used in Step 2. All of the color equipment added to this point will easily fit in five racks.

FIG. 27 (left). The studio color camera console includes a monochrome monitor (left) and a 19-inch console housing the processing amplifier and camera control panel. These units may be located at a separate position or assembled with the monochrome control consoles. The color monitor may be suspended from wall or ceiling (for easy viewing) or placed on the flat top of the 19-inch console (see Fig. 16, page 42). Alternatively both monochrome and color monitors, as well as camera controls, may be rack-mounted as shown in Fig. 28.



Studio Camera Control

The studio camera control equipment is similar to the film camera control supplied in step #2 and includes the same processing amplifier and master monitor. Mechanically, this equipment is housed in two console housing units and may be mounted next to the film camera control to form a single console, if desired. The advantages of standardization such as common tubes, panels and circuits are realized.

Electrically, the three video signals from the camera are fed directly to the camera control panel on which both operating and selected set-up controls are located. These signals are fed in turn to the processing amplifier which performs the functions of cable compensation, video amplification, blanking and shading insertion, feedback clamping, linear clipping, gamma correc-

FIG. 28. Either the film or studio camera controls may be mounted in a standard rack shell as shown here. When this is done the monochrome monitor is usually mounted directly above the camera control position and the color monitor in the adjacent rack at about the same eye-level. An arrangement of this kind saves floor space and is convenient for setup and maintenance. It is particularly useful in installations where the camera control position is in a room separate from the studio control room.



tion, and output amplification as well as providing auxiliary switching for the master monitor. The processing amplifier takes the place of numerous rack equipment items formerly required to perform the functions mentioned above.

It feeds a master monitor, which provides both kinescope and CRO displays of the processed camera signals, and a colorplexer, which combines the processed video signals into a single FCC standard color signal. The colorplexer feeds a tri-color monitor so that the color picture may be viewed by the video operator.

Colorplexer and Rack Equipment

The colorplexer, distribution amplifier, aperture compensator and miscellaneous power supplies are the step #3 items rack mounted. All of the equipment requiring

rack mounting can easily be accommodated by the two racks furnished.

The colorplexer operation is similar to that previously described in step #2. The R, G and B signal outputs of the studio color camera are fed into a colorplexer, just as are the outputs of the film camera. A colorplexer is supplied as part of each camera chain. The video signal from each chain is an independent compatible color signal. The color bar generator is used to align the colorplexer which can be adjusted for perfect matrixing. Using this adjustment as a reference, and color monitor for observing, the elements of the camera chain can be lined up for the best possible picture. An aperture compensator, a 2-inch high unit, is mounted above the colorplexer and connected to function as part of the colorplexer's luminance channel.

Monitoring

In step #3 (as in step #2) a monochrome master monitor (TM-6C) and a color monitor (TM-10) are furnished. The master monitor which is mounted in the console housing permits the checking of levels of individual color signals and camera registration. The video operator sees the picture in black-and-white on the camera control monitor and he may select a black-and-white presentation of a separate red, green or blue signal or any combination (red plus green, green plus blue or red plus green plus blue). A color picture presentation can be seen on the color monitors. The color monitor is a separate unit and may be mounted in a rack, suspended, or placed atop the flat deck of the control console. Since both camera control operators and directors need to see the monitor it should be placed at some vantage point.



FIG. 29. View of the new TS-11A Video Switching Panel shown mounted in the sloping desk section of a typical Control Console. The TS-11A provides 9 inputs and 3 rows of push buttons for fades, lap dissolves and super-positions.

FACILITIES FOR COLOR PROGRAM SWITCHING

The description on preceding pages has indicated how unit equipment groupings may be added step-by-step to increase the color video facilities of a TV station. Further increases can be made by installing additional film and/or studio cameras.

In most cases it will be desirable to add a complete equipment grouping for each camera (film or slide) which is added. This

arrangement (i.e., of making each camera chain a complete system in itself) is of enormous advantage in providing flexibility, facilitating maintenance and avoiding loss of air time because of failure in a single color coding equipment. It also makes for much simpler switching between cameras and between cameras and other program sources.

Only One Signal to Switch

Each camera chain (film or live) in the RCA system includes a colorplexer in which the red, green and blue signals from the camera are combined with the subcarrier to form a composite color signal. This eliminates the need for three identical sets of switching equipment (to switch the three separate colors). Because the output is a single signal (containing a subcarrier component), it is possible to handle all switching operations in the usual way, and to use any of the standard RCA monochrome switching equipment. (Note: minor modifications in existing switching equipment may be necessary in some cases.)

To insure that color synchronizing bursts are always in the proper phase relative to the subcarrier components of the video signal, burst keyers are provided within each colorplexer. This adds the bursts to the rest of the subcarrier signal as soon as possible after modulation, giving no opportunity to drift in relative phase.

The synchronizing signal is added at a common point after switching, so that control information to the deflection circuits of home receivers is never interrupted.

Standard Switching Equipment Used

The fact that any of the standard RCA monochrome switching systems can be used for color provides the color equipment planner with a wide choice. He may use the TC-4A, the TS-5A, or the TS-11A

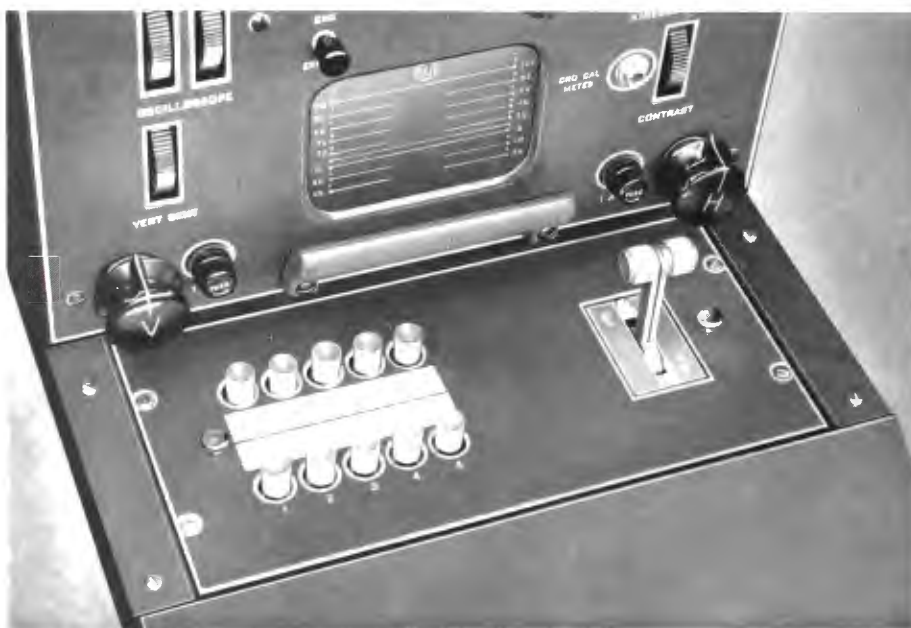

FIG. 30. View of the TS-5A Switching and Control Panel shown mounted in the sloping desk area of a standard control housing. The switcher may also be mounted above this level with other remote control panel mounted items.

mechanical switching systems or the TS-20 Relay Switching equipment.

The TC-4A Basic Buy

Many TV stations have already installed and are familiar with the RCA TC-4A ("Basic Buy") audio/video switcher. This provides video control and program switching selection of any of 8 signals, as well as audio control of 8 inputs to 4 mixer positions. Stations having this equipment will find it satisfactory for color as well as monochrome.

The TS-5A Five-Position Switcher

Stations which require more inputs than provided by the TC-4A can add the five-position TS-5A Switcher (see Fig. 30). This will provide five additional inputs as well as fading facilities and will make possible independent studio rehearsal. Such an arrangement is indicated in the diagram (Fig. 3, Pg. 31) of a "typical" monochrome station to which the color steps previously described are assumed to be added. As Fig. 17 and Fig. 25 indicate, the combination of the TC-4A and the TS-5A will provide switching of basic color facilities in addition to regular monochrome operations. If it is desired to have greater flexibility (for rehearsals, etc.) a second TS-5A might be added to be used for color only.

The TS-11A Nine-Position Switcher

For larger installations the new deluxe nine-position TS-11A Switcher is a good choice. This switcher (see Fig. 31) has nine input positions with three rows of push-buttons so that "preview" is available in addition to normal fades, lap dissolves and superimpositions. It will handle composite and non-composite video switching and fading, either color or monochrome.

Two of the three rows of push buttons feed a manual fader assembly and the third row is the preview channel. A program transfer switch is provided to interchange the preview and fader busses so that the fader section can be used for previewing fades, lap dissolves and superimpositions. This also makes it possible to use the fader channel for rehearsals while the preview channel handles the on-the-air signal. The fader assembly feeds a mixing circuit and three program line output amplifiers, eliminating the need for elaborate distribution amplifier systems on the output of the switcher. Sync is also mixed in this new switcher which is free of microphonics and low frequency tilt and bounce. Thus a stabilizing amplifier is not required as part of the switching system.

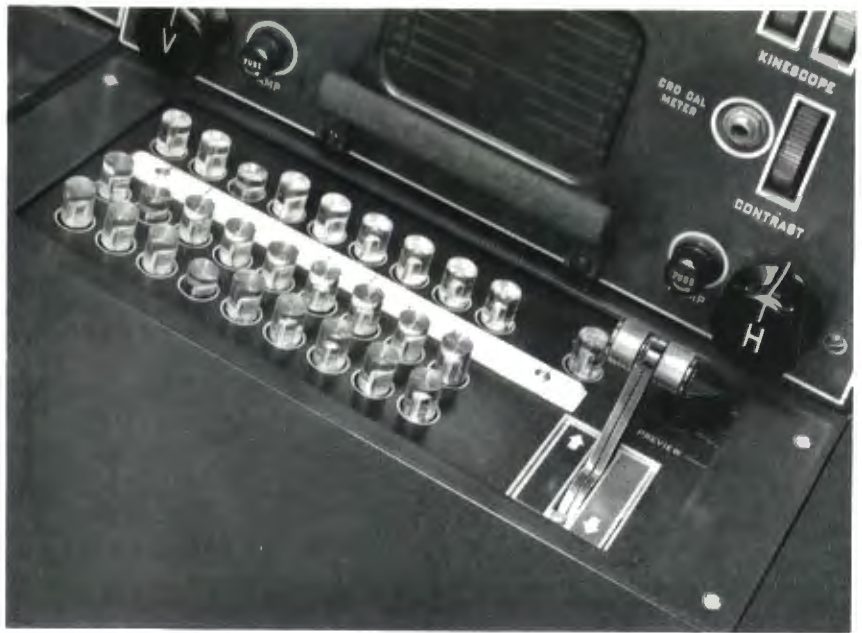

FIG. 31. A close-up view of the nine-position TS-11A Switcher. For deluxe installations, or those which have outgrown the TS-5A, this new switcher is the ideal choice.

TS-20 Relay Switching System

Where requirements dictate a still more flexible switching system or where more than nine video inputs are used, it is recommended that a relay switching system be considered. The *TS-20 Relay Switching System* is designed for use in television studio control and master control rooms. It consists of different types and quantities of equipment depending upon the size and type of switching operation desired. The equipment may be used for switching a minimum of six inputs to two outputs or

a maximum of twelve inputs to six outputs (see simplified schematic, Fig. 32).

For the studio control room the system can be set up to provide complete facilities for program monitoring, video switching between television studio cameras, film cameras, remote pick-ups or network programs. Controls can be provided for fading and lap-dissolving between local studio video signals. The system can provide for program previewing and many other monitoring functions.

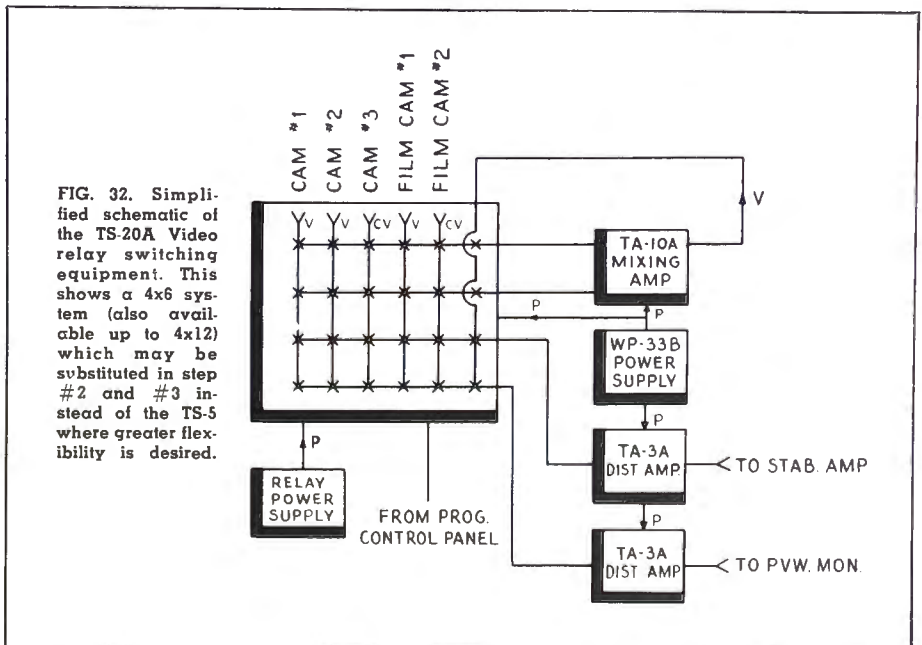



FIG. 33. WBAP-TV studio scene showing a typical color telecast. Note that the color cameras are used with standard type equipment such as two-man dolly and lighting equipment. Cooking demonstrations are in kitchen and interviews are held at left part of set.

SPACE CONSIDERATIONS FOR COLOR

Some present monochrome equipment may be adapted for color use—while other items will be retained solely for black and white use. In any case, a certain amount of additional space will be required. The total space a Broadcaster must provide for Color TV operations will vary according to the scope of the proposed operation. For example, “network color only” stations will require very little additional space—while those stations who plan to use slide, film and live camera facilities must do more serious planning.

From observations of many existing stations it is obvious that most will either have to hunt for additional space, build it, or take existing space for color use such as present AM space or even doubling up in present monochrome studios.

There are undoubtedly many ideas which may occur to individuals concerning their own requirements, as for example providing a second deck for a control room where ceiling height is not limited. The

description given here deals with space requirements as they apply only to items of equipment furnished in the three plans—and not on a general or overall basis. The reader is referred to BROADCAST NEWS No. 81 for descriptions of how operating TV stations have handled their space problems (see Fig. 33).

Rack Space Required

Fig. 26 shows a typical Step #3 rack layout for a station with slide, film, studio and “network” facilities. The units shown on the racks are the same as those shown on the functional diagram of Fig. 25. A station with no live cameras will have less equipment and, therefore, will require fewer equipment racks. Similarly, a station planning to use more cameras can easily estimate the additional rack space required.

Console and Camera Space Required

Each camera chain—whether slide, film or studio—includes two units designed for

console mounting. One of these is a master monitor and the other unit, a 19-inch unit, contains the color camera controls. The two units are mounted in standard console housings similar to those used in the RCA monochrome installations. These units, of course, can be combined with other camera units to form a control console of the standard type.

The color studio camera is larger than a standard monochrome camera. However, it is moved by similar type dollies and, therefore, does not in itself require more floor space. The film and slide camera space is indicated in the floor plan of Fig. 20. Here also space must be left for access and convenient working room on both sides.

The studio space required will depend, of course, on the scope of programming, number of cameras and other factors. Here again the reader is referred to BROADCAST NEWS No. 81 for description of operating TV stations color studios.

CHARTS SHOWING SPACE, WEIGHT AND POWER

Step #1—Color Network Operating Equipment

DESCRIPTION	HT.	DIMENSIONS		DP.	APPROX. WEIGHT	POWER REQUIREMENTS	
		WD.				AC (WATTS)	DC (MA)
Color Stabilizing Amplifier, TA-7B	10½	19		10¼	20	60	350
Color Monitor, TM-10B	26	22½		31¼	180	450	—
Low Frequency Phase Correction Equalizer	5¼	19		10	9	—	—
High Frequency Phase Correction Equalizer	17½	19		10	30	—	—
Video Distribution Amplifier, TA-3A	3½	19		10¾	12	55	140
Power Supply, 580-D	10½	19		12	58	370	—
Power Supply, WP-33B	14	19		9	82	400	—
Cabinet Rack, BR-84D	84	22		24¼	225	—	—
Video Jack Panel	3 15/32	19		9¼	8	—	—
Color Stripe Generator, WA-8A	8¾	19		7¾	20	125	—

Color Test Equipment for Network Operation

Linearity Checker, WA-7B	8¾	19		14	40	210	—
Color Signal Analyzer, WA-6B	17½	19		14	80	140	—
Burst Controlled Oscillator, WA-4A	8¾	19		14	40	165	—
Service Color Bar Generator, WR-61A	10	13½		7½	13	50	—
TV Oscilloscope, TO-524-D	15½	12⅞		22¾	61	500	—
Grating and Dot Generator, WA-3B	8¾	19		14	42	180	—
Calibration Pulse Generator, WA-9A	5¼	19		9	14	50	—

Step #2—Color Bar and Local Origination Equipment

Color Frequency Standard	7	19		7½	12	44	60
Burst Flag Generator	8¾	19		9	13	25	130
Power Supply, 580-D	10½	19		12	58	370	—
Studio Sync Generator, TG-2A	21	19		8¾	50	275	—
Cabinet Rack, BR-84D	84	22		24¼	225	—	—
Studio Color Bar Generator, WA-1D	14	19		9	30	135	—
Colorplexer, TX-1B	21	19		9	35	180	325
Sync Generator Changeover Switch	5¼	19		6	6	—	—
Changeover Switch Remote Control Panel	2⅝	11		—	2	—	—
Aperture Compensator	1¾	19		7	3	10	33

3-V Color Film and Slide Equipment

3-V Color Film and Slide Camera, TK-26A	57	41½		23¼	525	135	780
Multiplexer and 24 Volt Power Supply, TP-12	54	53		14	320	225	—
16mm Film Projector, TP-68C	54¼	22½		13⅝	450	1500	—
Dual Disk Slide Projector, TP-3C	14½	16		18½	30	300	—

(see Fig. 12 for complete Film Room floor space and ductwork plan)

Console Housing for Master Monitor	41	13¼		36	50	—	—
Console Housing for Processing Amp.	36	22		45	150	—	—
Master Monitor, TM-6C	18	13⅞		20	55	90	450
Processing Amplifier	10½	17½		21	35	50	350
Color Monitor, TM-10B	26	22⅞		31¼	180	450	—
Colorplexer, TX-1B	21	19		9	35	180	325
Aperture Compensator (for TX-1B)	1¾	19		7	3	10	33
Power Supply, 580-D	10½	19		12	58	370	—
Power Supply, WP-33B	14	19		9	82	400	—
Cabinet Rack, BR-84D	84	22		24¼	225	—	—
Video Jack Panel	3 15/32	19		9¼	8	—	—
Video Distribution Amplifier TA-3A	3½	19		10¾	12	55	140
Pulse Distribution Amplifier TA-4A	3½	19		10¾	12	55	120

Step #3—Color Studio Camera Equipment

Color Studio Camera, TK 41	27	44		21	300	190	975
Processing Amplifier	10	17½		21	35	50	350
Focus Current Regulator	5¼	19		9	22	85	12
Centering Current Supply	5	19		9	40	40	—
Colorplexer TX 1B	21	19		9	35	180	325
Aperture Compensator (for TX 1B)	1¾	19		7	3	10	33
Master Monitor, TM-6C	18	13		20	55	90	350
Color Monitor TM 10B	26	22		31¼	180	450	—
Console Housing for Master Monitor	41	13		36	50	—	—
Console Housing for Processing Amp	36	22		45	150	—	—
Power Supply, 580-D	10½	19		12	58	370	—
Power Supply, WP-33B	14	19		9	80	400	—
Cabinet Rack, BR-84D	84	22		24	225	—	—
Heavy Duty Pedestal, TO-4A	58	39		39	500	—	—
Video Jack Panel	3 15/32	19		9¼	8	—	—
Pulse Distribution Amplifier, TA-4A	3½	19		10¾	12	55	120

Intercom for Color

In any TV setup, a good *intercom system* is a necessity. The first significant step is when film facilities are added. In most existing stations some form of intercom system is in use, and the addition of color film into the same area may not require any additional talk circuits.

However, the addition of a color studio camera which has an intercom circuit built in, will require terminal equipment for communication in accordance with the number of cameras and control points involved.

Inasmuch as the intercom circuit constants are the same as those used in the RCA monochrome cameras they may be easily integrated with an existing monochrome system.

Fig. 34 shows typical RCA intercom items which may be used for a color camera studio arrangement and a film projection room. A six station talk-listen intercom and amplifier set is shown operating between the control room and projection booth. This unit is quite effective because it does not require that the projectionist use a set of headphones and he can answer from almost any spot in the room.

Audio for Color

In general, audio equipment facilities for color are the same as those used for black

and white. For a complete description of such facilities, refer to BROADCAST NEWS No. 73 (March-April 1953, "Four Versatile TV Station Equipment Plans").

House Monitoring

Two new types of RCA Monitran units have been designed for color. The type TM-40 monitran is an all channel unit which permits the user to select any TV channel from 2 to 13. The type TM-41 monitran is a factory tuned unit which will operate on any single channel specified for the user. These units may be used to distribute a modulated r-f signal to color receivers for house or studio monitoring purposes.

Microwave Equipment for Color

A new microwave system, type TVM-1A, has been designed to transmit both color and monochrome. The specifications of this equipment are such that it is capable of adequately meeting the requirements of a Color Television system. In the TVM-1A microwave transmitter, power has been increased over that of previous models to give more reliable transmission over longer distances. This increased power makes economical multi-hop operation feasible for both color and monochrome transmission. In monochrome use, the TVM-1A is a substantial, superior system offering increased stability, ease of operation and excellent performance characteristics.

It is possible that the broadcaster already may have an RCA TTR-1A/TRR-1B in monochrome operation. While the new TVM-1A microwave is recommended for the step to color, it should be remembered that the RCA TTR-1A and TRR-1B microwave equipment may be modified for this purpose.

HELP IN MAKING YOUR COLOR PLANS

Every television station will have its own special problems in converting to color. RCA Field Sales Engineers have been provided with the information needed to help stations solve these problems. They have detailed information on all RCA Color TV Equipment, including suggested arrangements for every size station. In the case of stations needing special switching arrangements, or other custom built equipment, they can call on the RCA TV Systems Engineering Group for assistance. This help is available to all stations without obligation.

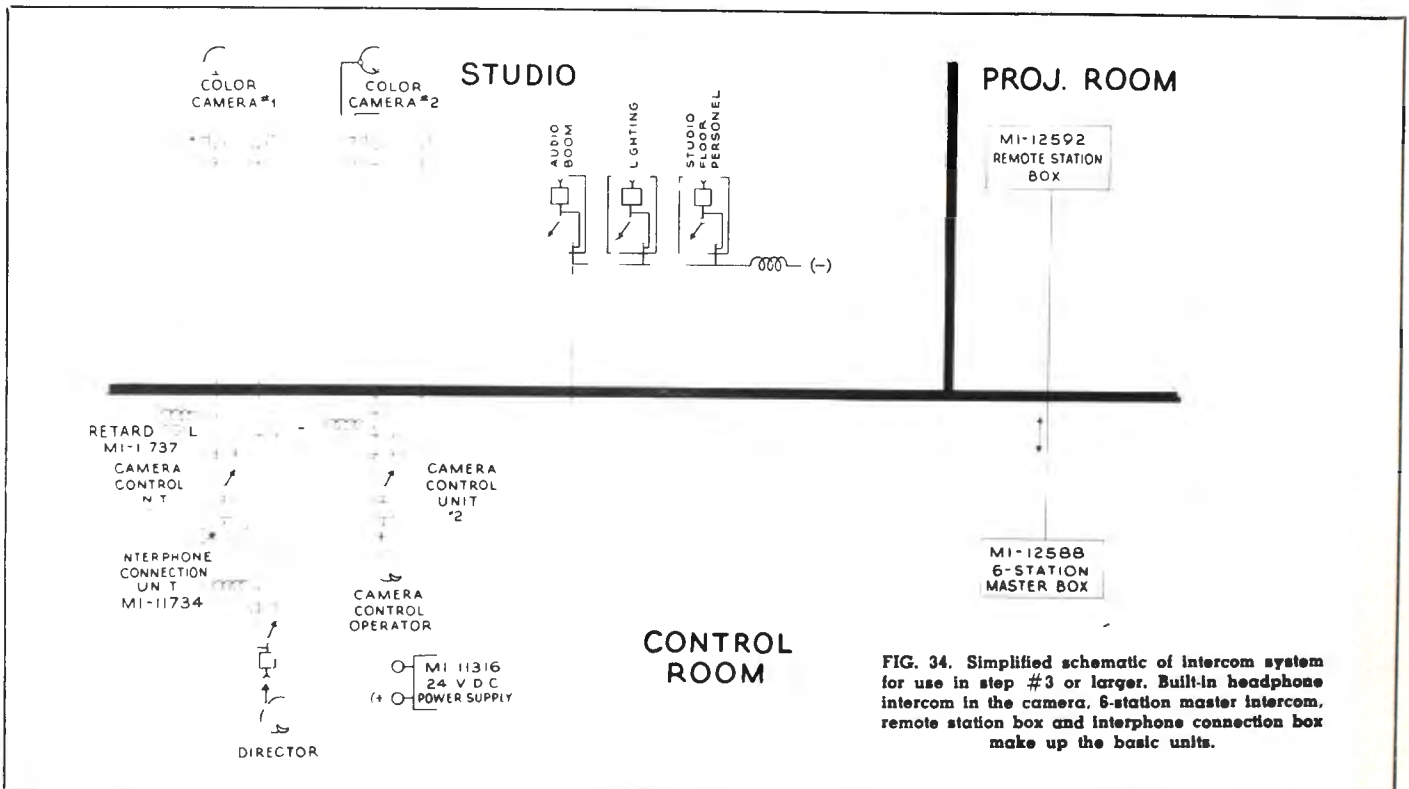

FIG. 34. Simplified schematic of intercom system for use in step #3 or larger. Built-in headphone intercom in the camera, 6-station master intercom, remote station box and interphone connection box make up the basic units.

TS-11A Switcher Offers New "Preview" and "Rehearsal" Features

by
C. R. MONRO
TV Terminal Engineering

A single video switcher, along with its audio counterpart, forms the central program control point for many TV broadcast stations now in operation. For several years RCA switchers have filled the requirements very successfully. But, as each year finds both existing and contemplated station plans calling for ever increasing program traffic, additional video control facilities will be needed. It is to fill this need that the new TS-11A Studio Switcher has been designed. Occupying the same single console area as former switchers it offers many new operational features for switching preview and includes all necessary output line amplifiers and sync mixing circuits in a single chassis.

Front Panel Features

As a part of the overall TV station plant, the video switcher pays its way in program versatility and operational smoothness which it offers. To the already familiar switching bus and fader arrangement, which has become a basic standard for television programming, two major facilities have been added: (1) full preview of all inputs and (2) means for providing a direct air channel by use of the new Preview Switching bus.

Much greater freedom in control room layout may be gained without sacrificing the program director's view of camera pictures, since he may check every signal source on a single preview monitor. This preview monitor may be used to line up cameras for the next scene in a live program, to cue in or check film or slides, or to obtain a switching cue from the network or a remote. It may also be used as a standard monitor with which to set picture levels and double check picture quality with the various camera control monitors.

"Preview" via the Program Transfer Switch

With other fader arrangements in which the fader output is fed directly to the outgoing program line, it is difficult to line up cameras for a special superposition or dissolve effect without using the fader output. A means to free the fader for preview while carrying a direct camera signal on the output program line is needed. Most large network installations provide a completely separate row of pushbuttons (the Program

Bus) for this purpose. Essentially the same operational advantage is provided in TS-11A, by using a Program Transfer Switch. With this switch in its normal position (Fader) the Program Output Channel is fed from the fader while the Preview Output Channel is fed from the Preview pushbuttons. With the switch in its other position (Preview), the Program Output Channel is fed from the preview pushbuttons, while at the same time, the Preview Output Channel is fed from the fader. Thus the special preview feature needed is provided in a single rotary switch. (See Fig. 1.)

"Rehearsal" via the Program Transfer Switch

There are several other uses for the Program Transfer Switch which may be valuable in certain installations. A station which obtains a large proportion of its daytime program material from the network or from film would find the rehearsal feature very useful. Instead of being forced to schedule rehearsal at odd hours when the switcher is available, the fader and its input switching pushbuttons may be fed to preview and floor monitors for rehearsal while the film or network show is carried directly through the preview pushbutton circuits. Instant return to normal operation is possible for station breaks or spot commercials. If "normal" operation is reversed, i.e., the program normally carried on preview pushbuttons, then a type of "preset" operation is possible. Two signals may be set up on the fader switching busses, checked on the preview monitor, then quickly inserted by a simple sequence of turning the transfer switch, showing the first picture, fading to the other, then switching back to the original program.

Mechanical Design

The complete Switcher is designed to fit into a single standard console housing. The housing may also contain a Master Monitor for use with the switcher, or it may contain a frame of remote control panels. A view of a representative console arrangement with the TS-11A installed below a Master Monitor is shown in Fig. 2. The pushbutton panel appears in the sloping desk area, directly under the Monitor. A close-up of the panel, Fig. 1 illustrates the pushbuttons and controls available. The lower two rows of pushbuttons on the panel feed any of nine input signals to the fader assembly.



FIG. 1. Close-up of TS-11A Control Panel. The lower two rows of pushbuttons feed any of nine input signals to the faders. The upper row is for preview. A Program Transfer Switch (above the faders) allows Preview and Fader channels to be transposed for special program applications.

The fader assembly itself is the latest design with rugged metal control levers, knobs, and closely adjustable mechanical stops. The new knob design provides a quick, positive locking feature which permits trouble-free transition from normal lap-dissolve (locked) operation to special super-position or fade-to-black (un-locked) position. The pushbuttons in the upper row are used for full preview, bridging every input circuit to the fader selection push-buttons. A tenth button in the upper row is a push-push switch. It is used to change from normal preview to input fed only to the preview output channel. The rotary switch above the fader is the Program Transfer Switch. It is used to transpose the Preview and Fader Channels for the special operational features which were just discussed.

The whole control panel, held by two thumbscrews at the front, is hinged so that it can be lowered to clear the Master Monitor if the Monitor is removed from the console. The panel lamps may be changed in this position by sliding out the channels which contain them. A snap-on bottom cover plate provides access to the push-button assembly, the input video terminations as well as the shock-mounted input amplifier chassis and its associated adjustment controls.

The main chassis of the switcher is located in the lower portion of the console as shown in Fig. 3. Here are located the mixer circuit tubes, the four output line amplifiers, sync interlock relays and control toggle switches, and the filament and bias supply. All tubes face forward for ready access after removal of the regular lower cover of the console section. This chassis is held at the top by thumbscrews which hold it firmly in place when the control panel is hinged down. By loosening these thumbscrews the whole assembly of control panel and main chassis can be hinged down to the floor. This exposes the wiring side of the chassis for test. All co-ax, power, and tally circuit connectors are located across the bottom of this back area on a raised panel which may be hinged up for access to the transformer and wiring. Finally, after removal of all cables, the whole assembly can easily be lifted from the housing.

Electrical Design

As demonstrated in the block diagram, Fig. 4, switching is accomplished with mechanically interlocked pushbutton switch units. These fulfill the requirements for video switching and offer long life under rugged conditions. Special precautions such

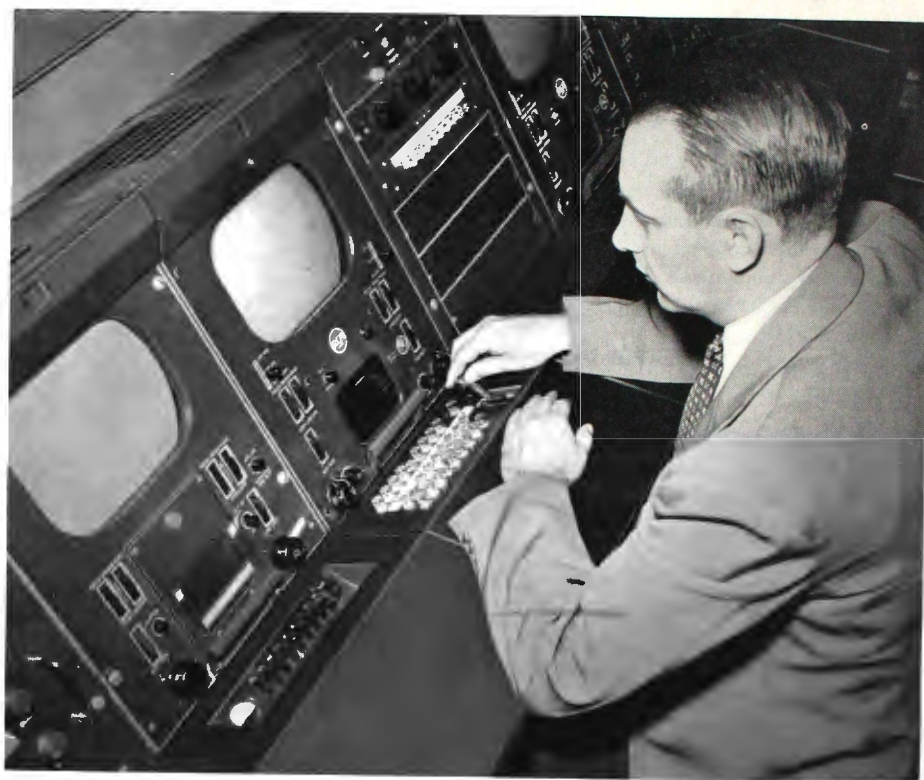

FIG. 2. A typical control room setting showing the TS-11A Control Panel mounted in the indented desk section of a standard RCA console housing. The housing here also contains a Master Monitor which may be used as a Line Monitor or Preview Monitor for the switching system.

as solid silver alloy contacts, special wear resistant phenolic sliders and careful lubrication assure dependable operation. Twin contacts are provided for the video circuits offering a choice of gap or overlap switching sequence. Normal factory connections will be for overlap on the fader channels, and gap on the preview channel. The owner may change connections by simply moving one wire at each switch video contact. Additional contacts on each switch assembly are used for the tally, sync interlock, and audio-tie circuits.

The video circuits from the pushbutton switches are fed through input isolation stages to permit accurate input termination and to minimize capacity loading. After going through the fader potentiometers, the signals are fed to matching gain stages for both preview and program. This is a necessary condition for proper operation of the program transfer switch because no change in level or frequency response should occur at this point. Signals now go from the transfer switch to the output line amplifiers. Four of these amplifiers are provided; three for program, one for preview. The line amplifiers are actually single-channel distribution amplifiers which provide sending-end termination for the outgoing cables as well as sync addition and a high degree of isolation between lines. Feedback cir-

cuits provide excellent stability, frequency response and linearity.

The Monitor Switch, mentioned before as the tenth Preview input, actually is a break-in circuit located between the transfer switch and the Preview Output amplifier. It permits monitoring of one of the program output channels as a "Line" monitor or for monitoring any other composite signal such as "off-the-air."

The "on air" tally circuits are controlled first by the pushbuttons, then by the position of the fader levers, and finally by the position of the transfer switch. Thus an actual "on air" indication is sent out to the various cameras being used. Since many varieties of cameras, old or new, live or film, color or monochrome, may be found in the system to which the TS-11A must be fitted, various tally voltages are provided. All inputs receive a 6.3 volt a-c circuit. The five inputs which are normally used for local signals also provide +280 volts d-c (through a dropping resistor). Either or both of these circuits may be operated from 24 volt d-c by changing jumpers in the connection plugs.

Since sync addition is provided in each of the output amplifiers, it is necessary to turn these circuits on or off depending upon whether the signal being carried is local (non-composite) or remote (composite).

This is accomplished through d-c circuits on the various front panel controls which operate two relays on the main chassis (one for program, one for preview) and are used to switch the actual sync signal.

Input Selection

The control circuits on the panel are arranged to suit the normal choice of inputs used in studio installations. Five of the inputs (#1 to #5) provide for sync addition at the output at all times. These would normally be used for local camera sources. Two inputs (#6 and #7) may be either local or remote, the selection available at a toggle switch located on the main chassis. Normally the choice would remain for usual program plans, and the toggle switch would then only be used in case of a special or emergency patch.

One input (#8) is arranged to remove local sync addition so that it may be used for network. The ninth position, on the other hand, always provides for sync addition. In monochrome service this input will usually be used for release or black. In color service, the ninth position would also be used for black, but in this case must be fed with a Black Picture signal. For this reason #9 has the same video input circuits as all other inputs. Where, in a special case, nine picture inputs are needed, a local signal may be patched in.

Sync addition is automatically determined as the various pushbuttons are used. The interlocking function, of course, is also run through the fader limit switches and through the Program Transfer Switch to insure transfer of sync control in relation to the signal actually being sent to the output amplifiers. Finally, the Monitor switch has a contribution to the sync interlock. When switched from normal preview to a remote signal, it transfers control of the preview sync addition from the preview pushbuttons to a fixed remote condition.

Audio-Tie

Extra contacts are provided on the Preview pushbuttons and brought out to a separate plug on the main chassis. In addition, a transfer set of contacts is also brought out from the Program transfer switch to the same plug. The title "audio-tie" has been applied to these circuits. In certain applications of the TS-11A, particularly those in which the switcher will be required to handle all of a station's video traffic, there are definite advantages to combined audio and video switching. This works best only where the audio and video signals are obtained each time from the same source. For instance, network video is always accompanied by network

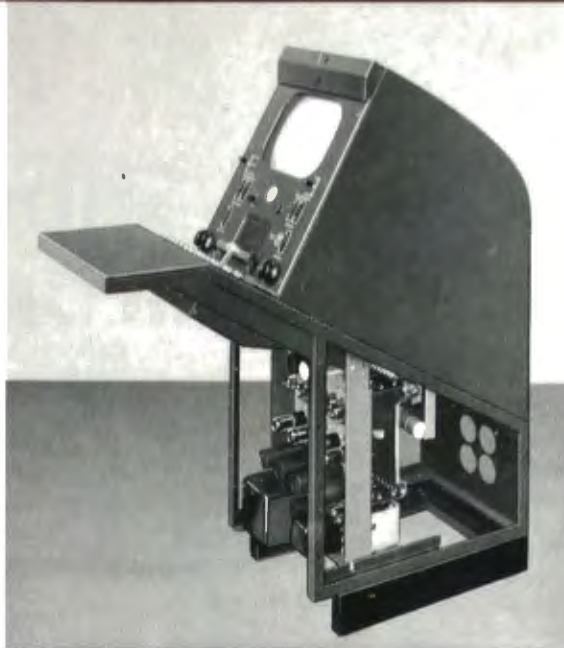
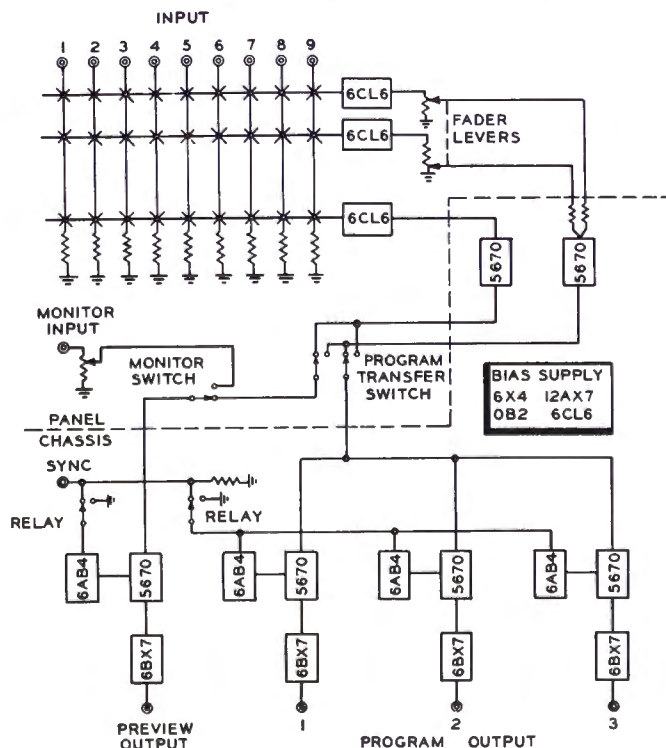

FIG. 3. The complete TS-11A Switching System comprised of Control Panel, Switching Chassis and Master Monitor is shown here mounted in a single RCA console housing.

audio. Other typical combinations which may be treated as pairs are remotes, film and projector audio, slides and announce booth. It may therefore be practical in some stations for one man to operate both audio and video switching from the single TS-11A console position. The Program Bus arrangement in the TS-11A lends itself to such an operation. With appropriate relays in the audio system, it is possible to transfer control of these certain audio inputs to the TS-11A Preview Pushbuttons. When the transfer switch is turned to "Preview,"

the audio signals would be switched automatically. Instant return to normal operation from the TS-11A Fader and the separate audio consolette would result from turning the transfer switch back to the Fader position. This would also apply to break-ins for special combinations. For instance, the video could remain on film by using the same input selection in both the Preview and Fader channels, while the audio could be transferred from projector audio to another signal such as announce booth as set up on the audio consolette.

FIG. 4. Simplified block diagram of the TS-11A Switcher.



Reduction of Spurious Signals in Image Orthicon Cameras...

This article describes various spurious signals generated in image orthicon pickup tubes and suggests methods of tube operation which minimize the unwanted effect of these spurious signals. Spurious signals are classified in accordance with the part of the tube in which they are generated and the visual effects they cause. Wherever possible, the physical reasons for the spurious signals are explained.

Classification of Spurious Signals

Although detailed description of the image orthicon and its operation is not within the scope of this article, it is necessary to review briefly the image orthicon structure so that the spurious signals may be classified according to their place of origin inside the tube. It will be assumed that the reader is familiar with the operation of the tube as described in the references in the bibliography.

As shown in Fig. 1, the tube is divided into three main sections: the image section, the scanning section, and the multiplier section. In each of these sections, spurious signals can be generated and superimposed on the video signal. Therefore, the spurious signals will be classified in three main groups depending upon the section in which they originate.

By

A. A. ROTOW

Tube Department, RCA, Lancaster, Pa.

THE IMAGE SECTION Photocathode

In the image section, the optical image is projected on the photocathode. If any stray light falls upon the photocathode, either directly through the lens system or because of light leakage elsewhere in the camera system, the effect called "lens flare" becomes evident. Lens flare appears in the picture as washed-out areas of low contrast. The first step to take towards the elimination of this effect is to make sure the camera and turret are tightly closed. After this step, any stray light in evidence must pass through the lens system and may be eliminated or greatly reduced by the use of a cylindrical lens shield having a non-reflective black inner coating. When these two steps are taken, flare will usually be insignificant unless a strong light enters the lens at an angle.

Photocathode spots and smudge can also cause spurious signals. Such spots and smudge, however, may be made unobjectionable if they can be defocussed by

means of the image focus voltage control (on the camera control unit) without causing noticeable decrease in the resolution of the picture. In general, photocathode spots are least objectionable when the picture is in best focus. The spots are usually dark on one side of focus and white on the other.

Several other spurious signals can also be generated in the image section as a result of redistribution of secondary electrons on the target. The effects of these signals are known as:

- (1) Highlight flare or "ghost",
- (2) Black Border, and
- (3) White Halo.

These effects, which have been described in detail in a previous article,³ can occur only when the tube is operated above the "knee" of its characteristic curve. Generally, they will not be objectionable unless operation is far above the knee. The black border, in fact, is desirable in areas that have detail because it improves contrast at highlights.

Tubes now in the field are all of the "anti-ghost" design, and ghost effect is eliminated automatically. Even in these tubes, however, the ghost effect may occur if the tubes are not operated at the proper

FIG. 1. Cross sectional diagram of image orthicon tube shows details of image section, scanning section, multiplier section.

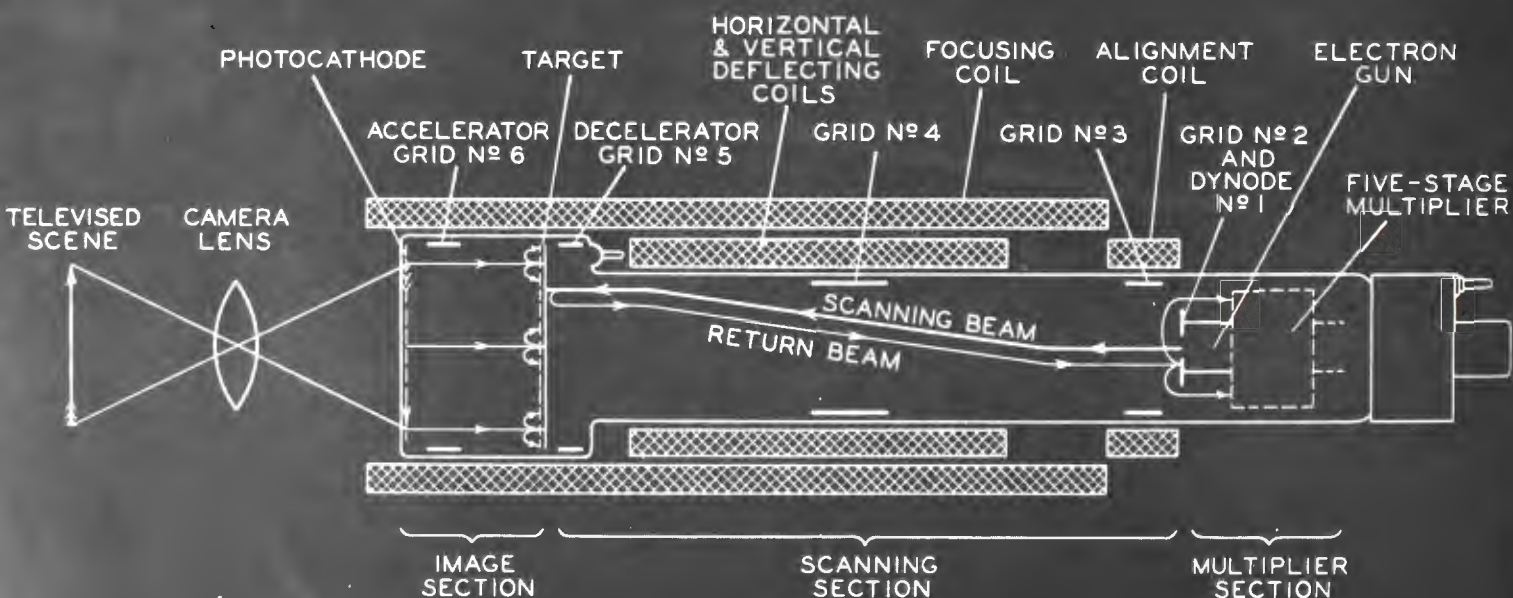

voltages. It is important, therefore, that the grid-No. 6 (accelerator-grid) voltage be set at 75 to 80 per cent of the photocathode voltage as suggested in the tube data. Operation of grid No. 6 at other voltages will result in either ghost effect or "S" distortion of the picture.

The black-border and white-halo effects cannot be eliminated unless the tube is operated below the knee. The black border, however, is often a desirable effect in areas that have detail because it improves the contrast at high lights.

Target-Screen Assembly

The target-screen assembly which divides the image section from the scanning section can also be a source of spurious signals. The spurious signals which may be generated in this assembly are:

- (1) Target mesh spots,
- (2) Target mesh smudge,
- (3) Mesh beat pattern,
- (4) Uneven signal,
- (5) Microphonics.

Target mesh spots and smudge are similar in appearance to photocathode spots and defects. Defects on the target, however, are not affected by changes of the photocathode voltage (image focus). The effect of target spots and smudge may be minimized by adjustment of the grid-No. 4 (beam-focus) voltage to defocus them as much as possible without impairing the resolution. Because these spots and smudges are often intensified by unusually high or unusually low signals from various surfaces, slight changes in the lens stop may help to make spots and smudge less prominent.

The mesh beat pattern, which appears on the picture as a moiré pattern, is caused by the beating of the scanning lines (525 per frame) against the lines of the mesh screen (500 per inch).

Although this effect is reduced by mounting the mesh screen so that the rows of its openings are at a 45-degree angle with the scanning direction, a beat pattern may appear under the following conditions:

- A. If the scanning section of the tube has an abnormally high resolution,
- B. If the front socket is not mounted at the correct angle with respect to the scanning yoke,
- C. If the focusing magnetic field is reversed.

The magnetic field normally should be such that a north-seeking pole is attracted to the image end of the focusing coil when

the magnet is held in front of the coil and outside of it. If the field is reversed, the scanning raster will be rotated with respect to its correct position by about 8 degrees. Because the angle of the screen with respect to the scanning raster is kept within 45 degrees plus or minus 2 degrees, the angle between the scanning direction and the direction of the screen openings may be 45 degrees plus or minus 8 degrees plus or minus 2 degrees, or 35 degrees to 55 degrees, and a beat pattern will appear. If a beat pattern appears, the direction of the focusing magnetic field should be checked, and reversed if necessary. In case the beat pattern is still troublesome then proceed as follows:

1. If the beat pattern appears on all (or the majority of) tubes in the camera, it is likely that the angle between the front socket and the yoke is incorrect; the scanning yoke should be replaced.

FIG. 2a. Oscillogram of perfectly uniform signal. FIGS. 2b and 2c. Oscillograms showing two kinds of white level distortion. FIG. 2d. Black level distortion in the image orthicon.

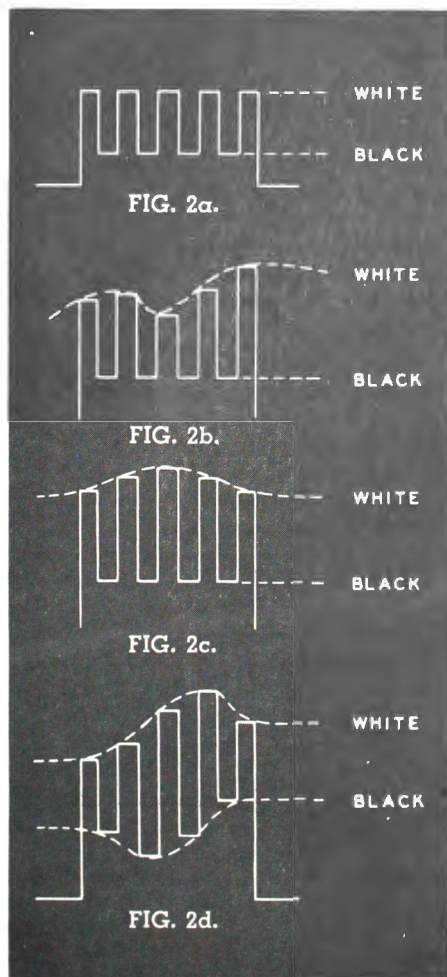

2. If only a few tubes show a beat pattern, these tubes probably have abnormally high resolution. Two remedies can be tried on such tubes. First, the beam should be defocused. It should not be necessary, of course, to reduce the center resolution below a minimum of 500 lines. Second, the width and the height of the scanning raster on the target should be changed slightly.

Uneven signal can be caused at the target-screen assembly by:

- a. Difference in target-to-screen spacing,
- b. Difference in the secondary emission ratio of the image-side surface of the glass target.

The easiest way to rate the uniformity of signal is to "pan" the camera on a raster of black and white bars and observe the wave form on the oscilloscope of the camera control unit. When the signal is perfectly uniform, the oscillogram will appear as shown on Fig. 2a. If the signal is uneven, however, the upper ("white") end of the oscillogram will be distorted, as shown in Figs. 2b and 2c.

The lower or "black" level of the signal cannot be distorted by any effects occurring at the target because in this level the beam is reflected without reaching the target. A distortion of the "black" level, therefore, such as shown in Fig. 2d, indicates that a spurious signal has been introduced somewhere after the beam has returned from the target; these signals will be discussed later. A distortion of the lower "black" level may also occur, however, if the black bars of the raster are not perfectly "black". Even black velvet will reflect about 1 per cent of the incident light, and at very high illuminations the "black" bars of the raster may reflect sufficient light to distort the lower edge of the oscillogram, as shown in Fig. 2d.

If uneven landing is caused by differences in target spacing, different parts of the target area will reach the knee of the characteristic curve at different lens stops. When the tube is operated at the knee, therefore, the signal is uniform (Fig. 2a). As the lens is opened wider the upper or "white" level becomes distorted and the oscillogram appears as shown in Figs. 2b and 2c. The waveform of Fig. 2c is typical for a tube in which the mesh screen has become loose and is pulled in closer to the glass target in the center (by electrostatic forces); in such a tube, the capacitance is higher at the center of the target-screen assembly than at the edges. When the light level in such a tube is lowered (lens stop

decreased) and the target spacing is uneven, the signal flattens out and at low light levels is perfectly even (Fig. 2a). Distortion of signal caused by variations in secondary emission (or by an uneven photocathode surface) is similar in appearance to that caused by differences in target-screen spacing, as shown in Figs. 2b and 2c; however, the behavior of the signal with change in light level is reversed. In tubes having variations in secondary emission, the "white level" becomes distorted at low lights. As the lens is opened wider, however, and the tube reaches the knee of its characteristic curve, the maximum white signal stops rising; then, as the illumination is further increased, the other "whites" rise to the same level and the signal flattens out.

The unevenness in signal caused by these effects is often called bad "landing", although, strictly speaking, the term "landing" should be used only for effects which take place in the scanning section. Nevertheless, we shall use the term "landing" for these effects and, in general, all effects which take place with the lens open, the photocathode illuminated, and the target voltage above cutoff. We shall use the term "shading" to describe the influence on the video signal of all effects which take place with the lens capped and/or the target voltage at or below cutoff. This terminology is justified by the fact that if the photocathode is illuminated and the target above cutoff the beam "lands" on the target; if the lens is capped or the target at cutoff the beam is returned without "landing" on the target.

A final source of spurious signals generated at the target is microphonics. Both the target and the mesh screen are stretched on their support rings, forming circular membranes which can oscillate at certain frequencies. When oscillations start, the spacing between the target and the mesh screen changes. The effect of this change of spacing is visible as a ripple passing over the surface of the picture. Although microphonics may be generated in any tube by mechanical shock or vibration, in a good tube they are of very short duration when the camera is moved or the lens turret turned.

THE SCANNING SECTION

The following effects which generate spurious signals can take place in the scanning section:

- A. Bad landing of the beam on the target. This effect can be subdivided into (1) porthole effect and (2) uneven landing.



FIG. 3. "Porthole" effect as represented on picture screen.

- B. Ion spot.
- C. Generation of noise by secondary emission at the target.

Landing of the Beam

The optimum operating conditions of the tube with respect to landing may be explained better after a short simplified discussion of the landing of the beam. Fig. 1 shows a schematic diagram of the image orthicon. The beam comes out of the gun aperture with a velocity¹ of 300 electron volts, passes through the major part of the scanning section at a velocity of 180 to 200 electron volts, and, if the tube is illuminated, slows down³ to about 2 electron volts before it reaches the target. Some of the beam electrons are deposited on the target, neutralizing its positive charge; the remaining electrons are returned to the first dynode. If the tube is not illuminated or the target is at cutoff, the beam slows down to zero velocity before it reaches the target and is deflected totally toward the first dynode.

The scanning beam is magnetically focused and deflected. Because the force with which a magnetic field acts on a moving electron is always normal to the trajectory of the electron, the electron cannot get any energy from the magnetic field. The total energy of a beam electron as it approaches the target, therefore, is the same whether the electron hits the center of the target or is deflected to the edges of the target. The deflected electron, however, has a radial component of velocity, and the kinetic energy corresponding to this radial component must be subtracted from the total kinetic energy in order to obtain the kinetic energy in the axial direction of an electron in the deflected beam. The deflected beam, under some conditions, might not be able to reach the target at its edges and bad "landing" will take place. Under these conditions a dark area will appear around the picture, as shown on Fig. 3. This effect, known as the "porthole" ef-

fect should not be confused with uneven landing caused by a loose mesh screen, as shown by the oscillogram of Fig. 2c. The porthole effect is eliminated by means of the grid-No. 5 electrode voltage, as will be explained. This effect can still take place, however, if the tube is not operated under proper conditions, or if there are defects in the deflection yokes. Because this "porthole" effect is one of the most annoying spurious signals, its theory will be discussed in some detail.

The "porthole" effect may be illustrated by reference to a hypothetical scanning section having simplified electron-optical structure, as shown in Fig. 4. The space between the aperture and the target is maintained at the same potential because the first dynode and grid No. 4 are connected together and grid No. 4 is closed with a mesh screen in front of the target. (Tubes having such an auxiliary mesh screen have been built and tested and have shown very good landing but have not been standardized because of low resolution and high noise level.) Magnetic focusing and deflection fields in this hypothetical scanning section are perfectly uniform and do not have any fringe field. Under these conditions the velocity (although not the direction) of the beam electrons is the same over the entire scanning section, and the beam is deflected in two sharp bends at points A and B. The deflection path of the beam is shown in Fig. 5.

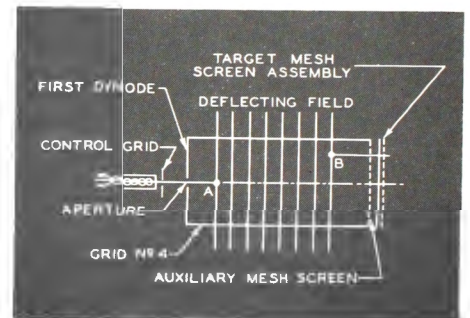

FIG. 4. Simplified diagram of a hypothetical scanning section.

Theoretically, the electron approaches the point A with an axial velocity V_A and no radial velocity at all. At the point A it is deflected in the direction A-B. The velocity V_A is then divided into two components: V_{AB} in the direction A-B and V_{AT} in a direction which compels the electron to make loops. The electron arrives at point B with a velocity component V_B equal to V_{AB} and V_{AT} . At the point B it is deflected back into the axial direction. The velocity $V_B = V_{AB}$ can be divided into V_A (axial) and V_{BT} which is normal to $V_B = V_{AB}$.

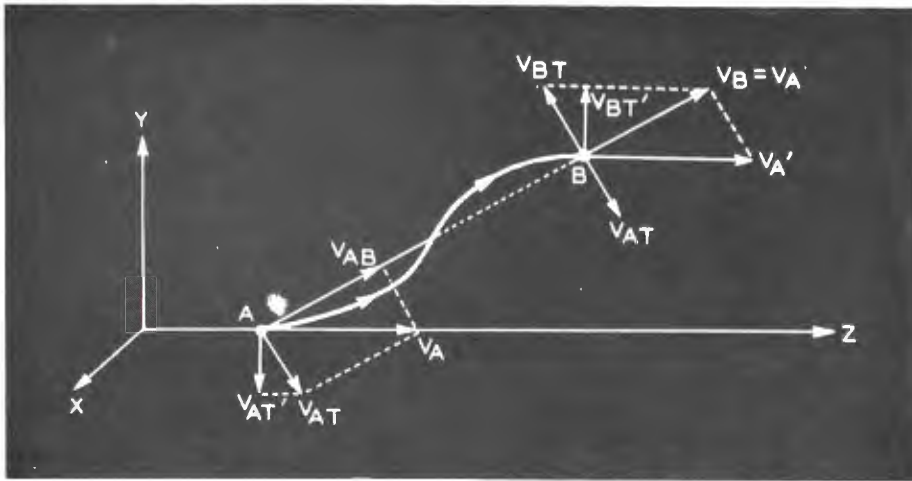

FIG. 5. Vector diagram showing deflection path of electron beam.

From the projection of the electron velocities on the X-Y plane as shown in Figs. 6 and 7, it can be seen that if the electron has made an integral number of loops between points A and B the components V_{AT}' and V_{BT}' are equal and opposed in direction. The electron, therefore, hits the target without any radial velocity component, as shown in Fig. 6. If, however, as shown in Fig. 7, the electron does not make an integral number of loops between points A and B, a radial component V_R will result.

By utilizing the law of conservation of energy, it can be shown that:

$$e\phi = \frac{m V_A'^2}{2} = \frac{m (V_A')^2}{2} + \frac{m V_R^2}{2}$$

where

- e = electric charge of the electron
- m = mass of the electron
- ϕ = potential within the scanning section

Thus, if V_R is less than zero, it follows that V_A' is greater than V_A . The deflected beam electrons near the edge of the target, therefore, will have smaller axial velocities than the electrons in the undeflected beam near the center of the target, and their energy may be insufficient to reach the target. This condition causes the porthole effect shown in Fig. 3.

Porthole Effect

In actual tubes, of course, the electric and magnetic fields are not uniform in the scanning section, as they were assumed to be in the hypothetical scanning section given above, partly because a screen is not used in front of the target. The components V_{AT}' and V_{BT}' , therefore, will probably never be absolutely equal even if an integral number of loops is placed between the points A and B. In addition, because of the fringe field of the deflecting coils the beam will not bend sharply but will be

gradually curving in the vicinity of points A and B. A radial component of velocity would, therefore, probably be present in the deflected beam as it lands on the target because the curvatures at these points will usually be different. To cancel this radial component an auxiliary electrostatic radial field is introduced by means of the electrode, grid No. 5, located in front of the target. The following practical conclusions are of value in determining operating conditions for the tube:

1. If the number of loops between the points A and B, as shown in Fig. 4, is not sufficient, the radial components of velocity at the target might be so great that the field of grid No. 5 would be insufficient to cancel it.

It has been found, in fact, that slight differences in yokes and sockets will cause a porthole effect. It has also been found that there is an optimum position of the tube with respect to the deflecting yoke (or of the electric field within the tube respective to the magnetic deflection field) which gives the best landing. Moving the tube even slightly away from this optimum position will result in porthole effect. If porthole effect is observed, therefore, the position of the tube inside the camera should be checked. The magnetic shield on the focusing coil may be moved backwards or forwards for optimum position. The iron wire used on the yokes should also be checked to determine whether it has become permanently magnetized.

2. The remaining radial component of the beam velocity at the target is cancelled by the field of grid No. 5. It may be anticipated, therefore, that the voltage of this electrode is critical. Experience has shown that even a slightly oxidized contact of the grid-No. 5 pin at the shoulder socket may cause very troublesome porthole effect.

When porthole effect is noticed, therefore, the grid-No. 5 pin should be cleaned with emery cloth, and all contacts connected to grid No. 5 and all grid-No. 5 leads should be checked.

Uneven Landing

Any departure from axial symmetry of the electric fields may cause uneven landing, which will appear not as a porthole effect but as a signal stronger at some places of the target and weaker at others (Fig. 2b). Similar effects may be caused by unsympathetic magnetic deflection fields, by magnetized magnetic shielding, and by the proximity of large masses of iron or strong external magnetic fields.

Best landing is usually obtained for a particular grid No. 4 voltage. This voltage

FIG. 6. Vector diagram without radial velocity component.

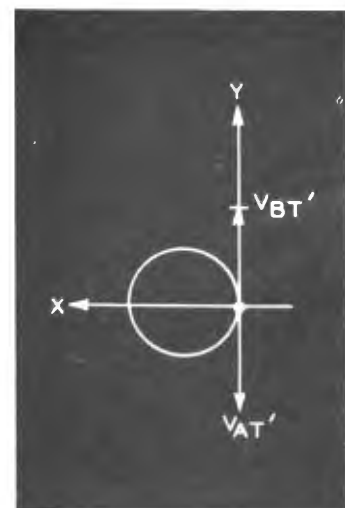
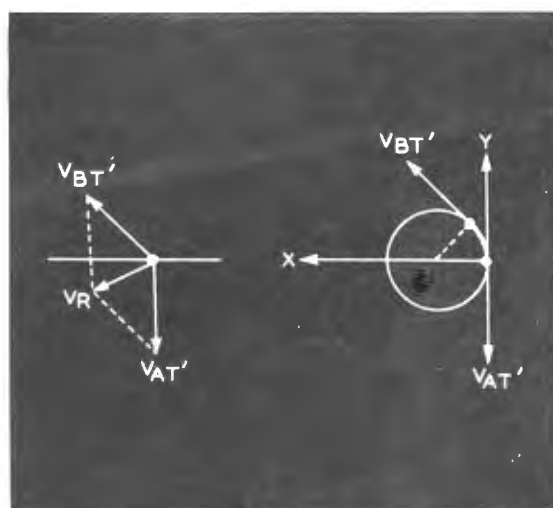

FIG. 7. Vector diagram with radial velocity component, V_R .



varies between tubes and is also dependent upon the particular focusing coil used. It is the voltage causing the beam electrons to make either five or six loops on the way from the aperture to the target.

Ion Spot

If the degree of vacuum in the tube is not sufficiently high, the electrons in the beam coming out of the aperture at a velocity of about 300 electron volts ionize the gas molecules by collision. The positive ions then drift towards the center of the target, which is the part at the lowest potential in the scanning section, and charge the center of the target positively. Even with the lens capped, therefore, a bright spot appears in the middle of the picture. If the ion spot is more intense, it appears even with the lens uncapped as a bright flare in the middle of the picture. If the beam current is increased, the ion spot increases in size and floods the whole target. Ion spots can usually be identified by the fact that the beam focus control has no effect on them. When the gas pressure in the tube is very high and the beam very intense, the target charges to such a high potential that the beam lands with sufficient velocity to eject an appreciable number of secondary electrons. The redistribution of these secondaries produces a dark area in the center of the bright ion spot. Oscillograms of typical ion spots are shown in Fig. 8a (low beam current and low gas pressure) and Fig. 8b (high beam current and high gas pressure). If a tube shows even the slightest traces of an ion spot it should be returned to the factory for re-processing. In general, however, ion spots are not very prevalent and should not be confused with other spurious signals, particularly large dynode spots which may be very similar in appearance.

Noise

Beam noise, which is due to the random velocity distribution of the thermionic electrons in the beam, may be objectionable if the secondary emission ratio at the scanning side of the target is high. This noise may be reduced by the evaporation of a very thin layer of silver (so thin that it will not cause target leakage) on the scanning side of the target after the tube has been evacuated. During operation of the tube, however, migration of cesium inside the tube and bombardment of the target by electrons may increase the secondary emission ratio on the target surface, causing the tube to become more noisy. Such a tube may be reprocessed at the factory by the evaporation of more silver on the target.

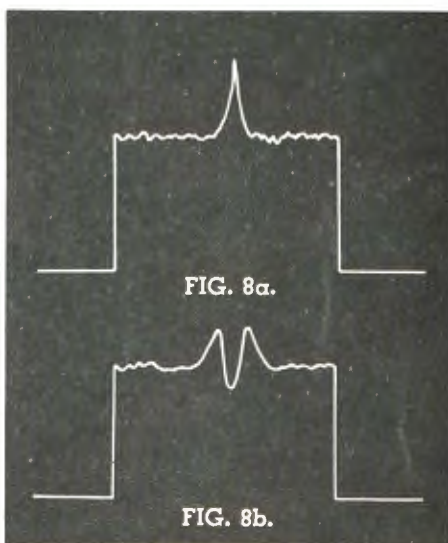

FIGS. 8a and 8b. Oscillograms of typical ion spots. FIG. 8a—low beam current and low gas pressure. FIG. 8b—high beam current and high gas pressure.

THE MULTIPLIER SECTION

Shading

Theoretically, in a hypothetical tube such as that shown in Fig. 4, all the modulated beam returning from the target should fall into the aperture from which it came and re-enter the gun. Such a tube, of course, would give no signal.

In actual tubes, however, the returning beam scans the surface of the first dynode around the aperture. The size of the scanned area is roughly from $\frac{1}{4}$ inch to $\frac{3}{8}$ inch on the diagonal, and its general appearance is a rectangle with rounded corners. This scanning is due to the radial electric field at the target, which causes the return beam to follow a slightly different path than that of the incident beam.

If the secondary emission ratio at the surface of the first dynode is not uniform, a spurious signal may be generated and superimposed on the video signal. The aperture, therefore, which has a secondary emission ratio of zero, appears as a white spot on the picture unless it is defocused. In addition, the percentage of secondary electrons from the first dynode which reach the second dynode (first pinwheel) may change from spot to spot of the first dynode, and also generate a spurious signal. Both spurious signals, that caused by uneven secondary emission at the first dynode and that caused by difference in collection of secondary electrons from the first dynode, are called "shading". The first effect is referred to as "bad dynode" and the second as "bad collection". Bad shading is generally more prominent when the camera is panned on a dark scene or when the lens is capped. Shading effects must not

be confused with "landing" effects, which take place only when the photocathode is illuminated.

Dynode Defects

Defects of the first dynode surface which cause bad shading can be divided into two main classes:

1. Defects such as spots and scratches which are present in the new tube; these defects are held to a minimum by careful manufacturing.
2. Defects which develop during the operation of the tube.

The second class of defects, these which develop during the operation of the tube, are the so-called "dynode burn" and "tear-drop spot".

The dynode burn is caused by a change of the secondary emission ratio of that area of the first dynode which is scanned by the return beam. This change takes place under the joint influence of the bombardment of the electrons from the returning beam and the temperature of the dynode heated by the gun. It will generally appear after some hours of operation of the tube. Why this effect takes place only on some tubes, and an exact explanation for it, are, for the present, unknown; this effect however, is still the subject of engineering study.

The appearance of a typical dynode burn, shown in Fig. 9, often causes it to be mistaken for the "porthole effect", which was shown in Fig. 3. These effects, however, can be easily differentiated because the porthole effect is seen only when the photocathode is illuminated whereas the dynode burn is most prominent with the lens capped.

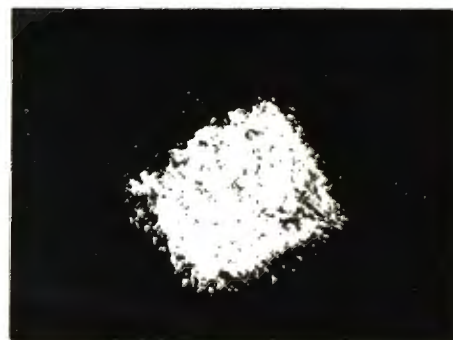

FIG. 9. Appearance of typical dynode burn.

If the dynode burn develops while the tube is operated at the highest grid-No. 5 voltage (90 volts), it may often be possible to continue using the tube by reducing the grid-No. 5 voltage so that the return beam scans a smaller portion of the first dynode within the dynode burn on its uniform light-colored inner part. It is,

therefore, a good practice to operate new tubes for several hours with the grid-No. 5 near 90 volts where this is possible.

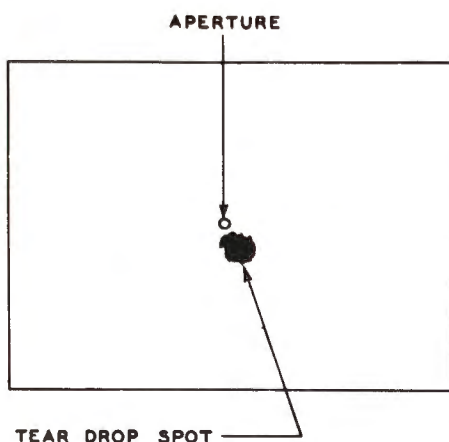

FIG. 10. Diagram showing "teardrop spot".

The "teardrop spot", which is shown in Fig. 10 is usually darker than the dynode surface and appears in the vicinity of the aperture. This spot usually results from the application of abnormal voltages or currents to the tube, and must, therefore, be attributed to improper operation. A condition such as loss of scanning and grid-No. 1 bias but with other electrode voltages, such as target, grid No. 4 and grid No. 3 present, is usually involved.

Bad Collection

Bad shading may also be due to variations in collection of secondary electrons emitted from different parts of the first dynode surface. Bad collection may be due to a variety of causes, some of which are:

- (1) Insufficient grid-No. 3 voltage,
- (2) Improper voltage on the first or second dynode,
- (3) Mechanical misalignment of parts of tube,
- (4) Stray magnetic fields,
- (5) Considerable masses of iron in the proximity of the tube.

A summary of the effects described in this article, together with recommendations for eliminating or minimizing the undesirable ones, is given in the following tables.

Bibliography

- ¹ A. Rose, P. K. Weimer, and H. B. Law: "The Image Orthicon, A Sensitive Television Pickup Tube", Proceedings of the I. R. E., Vol. 34, No. 7, Pp. 424-432, July, 1946.
- ² "Development and Performance of Television Camera Tubes", by R. B. Janes, R. E. Johnson and R. S. Moore, RCA Review, June, 1949, Vol. IX, No. 2.
- ³ "Light Transfer Characteristics of Image Orthicons", by R. B. Janes and A. A. Rotow, RCA Review, September, 1950, Vol. 81, No. 3.

Table I DEFECTS IN IMAGE SECTION

Defect:	Recognized by:	To Eliminate or Minimize:	See Page:
Lens flare	Washed out area on picture	Make sure camera and turret are tightly closed. Use lens shield.	60
Photocathode spots and smudge	Appears in picture	Defocus photocathode as much as possible without spoiling resolution.	60
White halo	White area around dark areas	Requires operation below the knee of the curve.	60

Table II DEFECTS AT TARGET SCREEN ASSEMBLY

Defect:	Recognized by:	To Eliminate or Minimize:	See Page:
Highlight flare or "ghost"	Highlights appear in double image	Set accelerator grid No. 6 to correct voltage.	60
Target spots and smudge	Appears in picture	Defocus target as much as possible without spoiling resolution.	61
Beat pattern	Appears as moiré pattern	Defocus target or change height and width of scanning raster slightly.	61

Table III DEFECTS IN SCANNING SECTION

Defect:	Recognized by:	To Eliminate or Minimize:	See Page:
Porthole	Dark area around lighter circular area with illuminated photocathode	Check position of tube and magnetic shielding in camera. Clean grid No. 5 pin, check all grid No. 5 leads.	63
Uneven landing	Signal uneven with light on	Make sure no parts of camera have become magnetized and no magnetic masses are close to the camera. Make sure tube is operated with the beam at the right order of focus. Check alignment.	63
Ion spot	Fairly large, hazy, white spot in middle of picture when lens is capped	Return to factory for reprocessing.	64
Noise	Appears in picture	Return to factory for reprocessing.	64

Table IV DEFECTS IN MULTIPLIER SECTION

Defect:	Recognized by:	To Eliminate or Minimize:	See Page:
Bad shading	Uneven signal with lens capped	Adjust multiplier focus, check position of tube in camera. Check for stray magnetic fields and magnetic masses. Check voltage on first and second dynode.	64
Dynode spots and defects	Appears in picture with lens capped	Defocus dynode by operating orthicon focus controls.	64
Burned dynode	Appears on picture with lens capped as more or less rectangular area lighter than the borders		64
Teardrop spot	Dark spots on dynode surface in vicinity of aperture	Prevented by avoidance of improper operation.	65



International Favorite: RCA TV

Two reasons why RCA is No. 1 in
World TV: RCA experience . . . RCA service

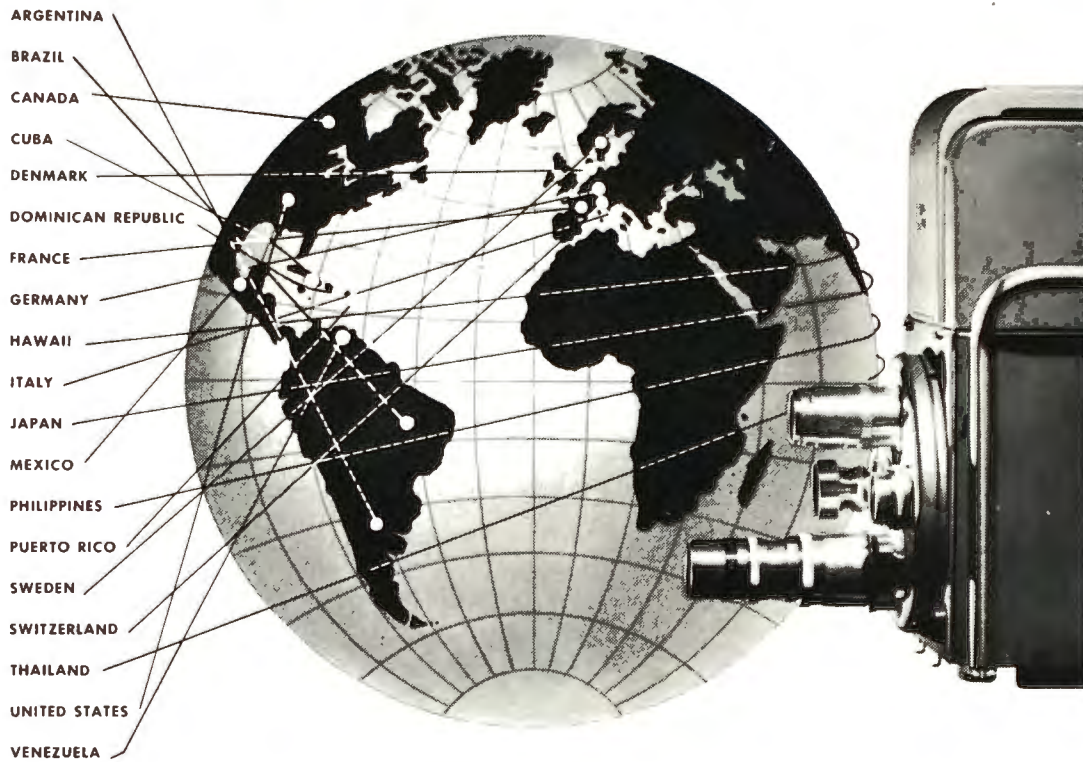

From one dependable source—RCA—you may order anything from a power tube to a complete television network . . . and be certain you are getting the finest.

RCA's breadth of TV experience is unequalled. For this company pioneered both black-and-white and compatible color television. In the United States, RCA transmitter equipment *and* home receivers are first in sales. RCA owns and operates five TV stations. It is affiliated with 182 others—the famous NBC network. To date, a total of 282 RCA television

transmitters have been installed in the United States and in other countries. The familiar RCA monogram is found on telecasting equipment in the studios of 18 countries beyond U. S. borders. And the list is steadily growing.

The reason is RCA's unmatched combination of experience in every phase of television plus its impressive reputation for service. This great reservoir of television experience and service facilities is at your command. For further information, see your RCA distributor or write to the address below.

TRADEMARK(S) • REGISTERED
MARCA(S) REGISTRADA(S)



RCA INTERNATIONAL DIVISION

RADIO CORPORATION of AMERICA

RCA BUILDING

30 ROCKEFELLER PLAZA, NEW YORK, N.Y., U.S.A.

Right from WJAC-TV's Station Log...

13,812 HOURS ON-AIR

... and still
going strong!*

* ... says *N. L. Straub, Technical Director of WJAC-TV*

"Over two years ago, we placed five RCA-5762 power triodes in our TT25AL Power Amplifier," says Mr. N. L. Straub of WJAC-TV. "... Placed in service in September, 1952, each tube has now a total of 13,812 hours service—and still going strong!"

The 5762 is but one of many RCA power types delivering long-life performance in radio and television transmitters all over the country. Broadcasters have come to depend on the reliable operation of these tubes—operation that *pays off!* Lower capital investment per hour of tube performance — lower operating cost — minimum "down time" — more stable operation are the kind of "extra dividends" broadcasters get from RCA Power Tubes.

Call your local RCA Tube Distributor to fill *all* your broadcast tube requirements. You'll like his friendly, prompt and dependable service.



RADIO CORPORATION of AMERICA
ELECTRON TUBES

HARRISON, N.J.



For the **right** start in **Color-TV**...

*you need this RCA Test and
Measuring Equipment "Package!"*

This indispensable package represents a basic "must" for a satisfactory color operation—network, film or live. You need it to check your station performance, maintain your broadcasting standards, assure the highest quality.

The various components of this vital "package" are pictured below. Charts at the right show how these units are used with relation to other station equipment as a means of providing complete testing facilities to meet various situations.

RCA engineers—the acknowledged pioneers in the development of compatible color television—have spent years developing this test equipment which takes the guesswork out of color broadcasting. Already, RCA color test equipment is proving itself in nearly 100 stations, assuring compliance with FCC standards of quality.

The "package" represents the minimum requirements for your station. For peak station performance each of these items should be included. In many stations the duplication of certain of the items will be desirable.

For experienced assistance in planning the installation of this equipment to meet your individual requirements, call on your RCA Broadcast Sales Representative. Or write RCA Engineering Products Division, Camden, N. J.

The 6 functions
shown here represent
the testing
facilities required
to attain and
maintain the
highest standards
in color operation



RCA PIONEERED AND DEVELOPED COMPATIBLE COLOR TELEVISION
RADIO CORPORATION of AMERICA
ENGINEERING PRODUCTS DIVISION
CAMDEN, N.J.

*You will need
all of these
5 instruments
for color test and
measurement...*



LINEARITY CHECKER
WA-7B



COLOR SIGNAL ANALYZER
WA-6A

1 Linearity Checker and Oscilloscope test for differential gain.

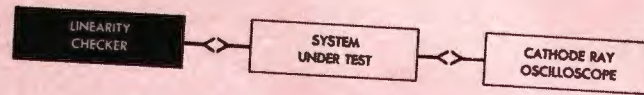

2 Addition of Color Signal Analyzer makes it possible to check differential gain and differential phase.

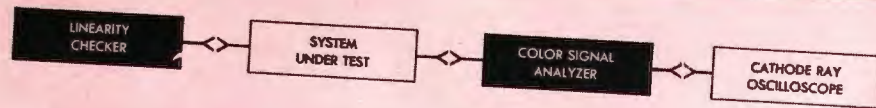

3 Burst-Controlled Oscillator must be added to check differential gain and phase at remote locations where studio sub-carrier is not available.

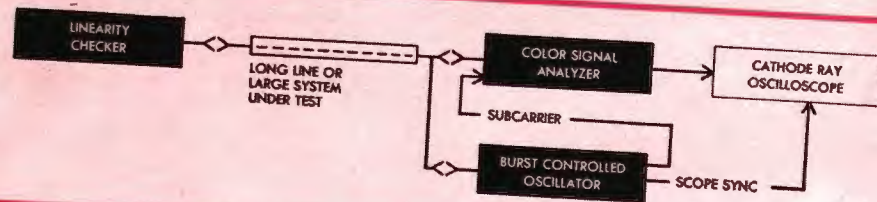

4 Grating and Dot Generator checks convergence and deflection linearity of monitors. Its signal can also be used for checking house monitoring systems.



5 The Color Bar Generator shown is used with origination equipment for supplying test signal to system. The Color Bar Generator in conjunction with the Color Signal Analyzer is used for precise alignment of the Colorplexer.

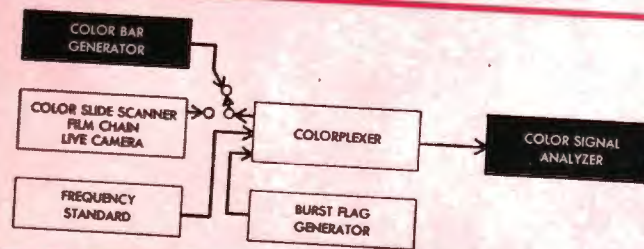

6 Integrated Test Equipment System for color broadcasting. This includes all situations depicted above.

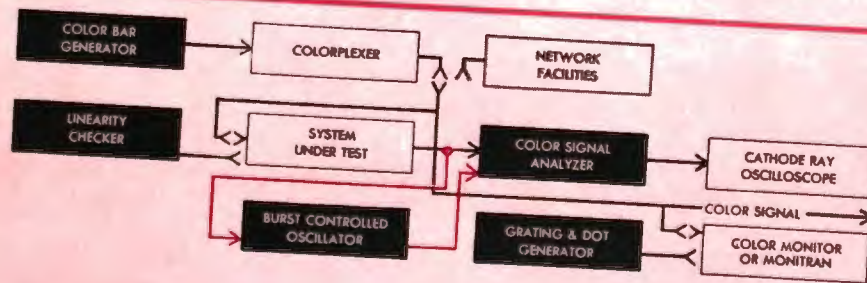

**BURST-CONTROLLED
OSCILLATOR
WA-4A**



**GRATING AND
DOT GENERATOR
WA-3B**



**COLOR BAR GENERATOR
WA-1D**

NOW...



RCA PRINTED CIRCUIT

PLUG-IN AMPLIFIERS FOR BROADCAST USE!

Provide These Outstanding Benefits...

SMALL SIZE . . . Considerably smaller than previous Broadcast Audio Amplifiers the RCA printed circuit series occupies about $\frac{1}{2}$ the rack and shelf space formerly needed. You free rack space for other AM and TV equipment, reduce rack and mounting shelf costs.

HANDLING EASE . . . Quick, safe and effortless installation or removal is assured by compact, light weight construction. Dependable 15-pin keyed connectors provide fool-proof positioning for rapid "in and out" handling. Connecting pins are gold plated to assure excellent electrical contact.

UNIFORM PERFORMANCE . . . The printed circuit assures uniformity and excellent frequency response. All units achieve extra dependability through use of hermetically sealed transformers. Each amplifier is provided with output terminals and a switch to facilitate current metering.

REDUCED-SIZE ACCESSORIES . . . Accessories such as BR-22A mounting shelf and BX-21A power supply used with the printed circuit amplifiers have also been "miniaturized." Example: shelf BR-22A, only $5\frac{1}{4}$ " high can accommodate the following combinations of equipment: 10 BA-21A Preamplifiers, 3 BA-23A Program Amplifiers plus 1 BA-21A, 2 BX-21A Power Supplies plus 2 BA-21A, 2 BA-24A Monitor Amplifiers.

For complete details of the many further advantages of RCA's printed circuit amplifiers, call your nearest RCA Broadcast Representative. Ask for literature.



RADIO CORPORATION of AMERICA
ENGINEERING PRODUCTS DIVISION
CAMDEN, N. J.

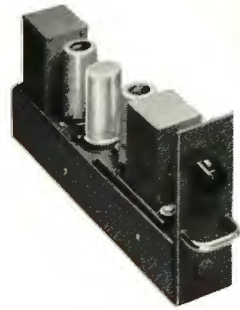

BA-21A PREAMPLIFIER . . . Ideal as a microphone preamplifier, turntable preamplifier or booster amplifier. May be used as isolation amplifier by adding an M-11278-E or F bridging volume control. Due to its small size, it may be placed in a control console, control desk or transcription turntable cabinet. One to ten of these units may be installed in a single BR-22A panel and shelf assembly.

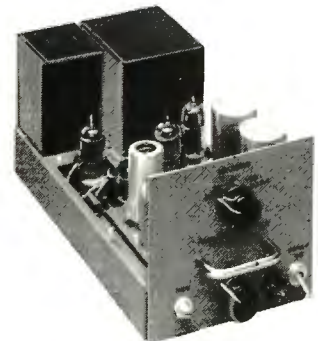

BA-23A PROGRAM AMPLIFIER . . . A versatile high-fidelity amplifier using special high-quality components and providing maximum accessibility. High gain and low distortion make it without equal as (1) program or line amplifier, (2) bridging amplifier, (3) isolation amplifier. Three BA-23A amplifiers can be mounted on BR-22A shelf with space for an additional amplifier.

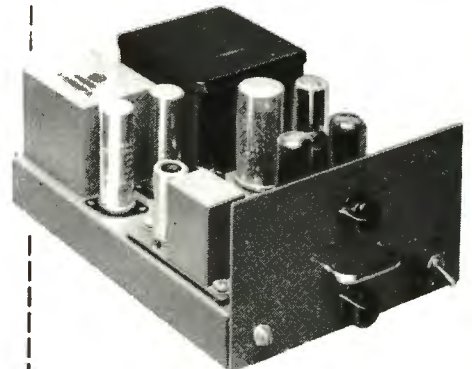

BA-24A MONITORING AMPLIFIER . . . A high fidelity, high-gain, flexible 8-watt amplifier suitable for monitoring, audition, recording and talk-back uses. Also serves as a program or line amplifier. Excellent for transcription playback booths, since the 105 db gain will operate a speaker (LC-1A) directly from the output of a turntable (70-series). Also an excellent recording amplifier.

New Business Getter

the RCA TV Switcher TS-5A

adds fades, lap-dissolves,
super-positions to spice up
your commercials



The RCA TS-5A Video Switcher is a flexible two-unit equipment designed to mount in a single standard console housing. The push-button and fader panel may be located as illustrated or in the upper face of the console. The TS-5A is designed for color use as well as for monochrome.

You are invited to ask your RCA Broadcast Sales Representative concerning the application of the TS-5A to your specific requirements, or write Dept. XXXX, RCA Engineering Products Division, Camden, N. J.

A MUST FOR YOUR TC-4A!

RCA's new TS-5A Video Switcher will give increased flexibility to your programming. If yours is a "Basic Buy" switching layout, where video control functions are centered around the TC-4A Audio/Video Switching Console, the TS-5A will supplement your present equipment, greatly enhance the versatility of your station, give new spontaneity to your commercials.

5 EXTRA INPUTS PLUS "REHEARSAL"

FOR YOUR TS-10A!

If your station already includes the TS-10A Studio Switcher and you need to provide for more inputs and rehearsal facilities—the TS-5A Switcher is the ideal answer. A typical arrangement of these two equipments will provide for independent studio rehearsal plus 5 extra inputs.

HANDY AS AN INDEPENDENT SWITCHER!

The TS-5A also may be used for independent switching systems where maximum program flexibility and economy are desired. The TS-5A can be conveniently mounted in a standard console housing adjacent to other console control units.



RCA Pioneered and Developed Compatible Color Television

RADIO CORPORATION of AMERICA

ENGINEERING PRODUCTS DIVISION

CAMDEN, N. J.

NEW



**BROADCAST
AUDIO
EQUIPMENT**

for

AM • FM • TELEVISION

- | | |
|-------------------------|-----------------------|
| MICROPHONES | RACK EQUIPMENT |
| CONSOLES | TURNTABLES |
| CUSTOM EQUIPMENT | RECORDERS |
| AMPLIFIERS | SPEAKERS |

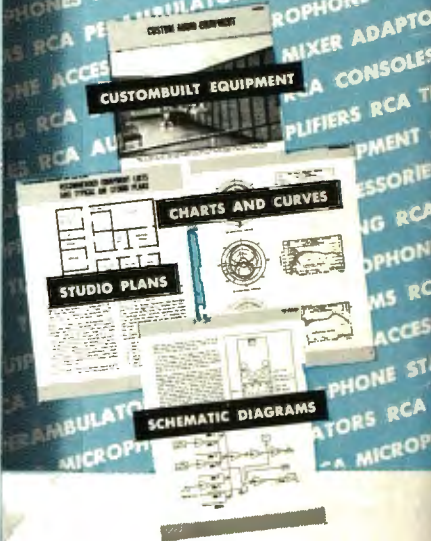

AUDIO catalog for Broadcasters

**AM
FM
TV**

THIS 146-PAGE CATALOG contains "straight-to-the-point" information about all RCA audio equipment and accessories designed for broadcast and television station operations. The book covers more than 200 professional audio items . . . and includes data, specifications, response curves, typical station equipment lists,

and studio layouts. It's authoritative. It's complete. It's the only book of its kind in the industry.

For your copy of the RCA Audio Catalog, ask your RCA Broadcast Sales Representative. Or write Dept. XX, RCA Engineering Products, Camden, N. J., on your station letterhead. In Canada, write RCA Victor Ltd., Montreal.



RADIO CORPORATION of AMERICA
ENGINEERING PRODUCTS DIVISION

CAMDEN, N. J.